

NEXUS ECONOMY drvene noge

NEXUS ECONOMY melamine legs

(Topovi stolova debljine 36mm / *desktop 36mm thick*)



BOJE - COLOURS

WL NE E

orah

walnut

SW 3A5



NEXUS ECONOMY drvene noge / NEXUS ECONOMY melamine legs

ZAJEDNIČKA OZNAKA	SLIKA	IZBOR BOJA	DIM.(cm) š d v	OPIS	SASTAV	PAK. kg m3 paketa
ARTICLE CODE	PICTURE	COLOUR SELECTION	DIM.(cm) w d h	DESCRIPTION	ASSEMBLY	PACK. kg m3 col

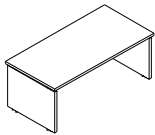
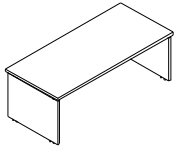

PRAVOKUTNI RADNI STOLOVI (DEBLJINA TOPOVA 36mm)

RECTANGULAR WORK TABLES (DESKTOP 36mm THICK)

9001 E		WL NE E	180 cm	Pravokutni radni stol 9001 E dimenzije 180x90x74h cm s drvenim nogama <i>Rectangular work table 9001 E dimensions 180x90x74h cm with wooden legs</i>	1 x 9001 E	80
			90 cm		0,1809	
			74 cm		2	
9002 E		WL NE E	200 cm	Pravokutni radni stol 9002 E dimenzije 200x90x74h cm s drvenim nogama <i>Rectangular work table 9002 E dimensions 200x90x74h cm with wooden legs</i>	1 x 9002 E	89
			90 cm		0,1843	
			74 cm		2	

ZAOBLJENI RADNI STOLOVI (DEBLJINA TOPOVA 36mm)

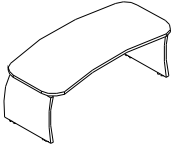
ROUNDED WORK TABLES (DESKTOP 36mm THICK)

9003 E		WL NE E	200 cm	Zaobljeni radni stol 9003 E dimenzije 200x95x74h cm s drvenim nogama <i>Rounded work table 9003 E dimensions 200x95x74h cm with wooden legs</i>	1 x 9003 E	91
			95 cm		0,2043	
			74 cm		2	
9004 E		WL NE E	110 cm	Zaobljeni pomoćni radni stol 9004 E dimenzije 110x70x74h cm s drvenim nogama <i>Rounded additional work table 9004 E dimensions 110x70x74h cm with wooden legs</i>	1 x 9004 E	48
			70 cm		0,1139	
			74 cm		2	

DODACI PRAVOKUTNIM RADNIM STOLOVIMA (DEBLJINA TOPOVA 36mm)

ENDS FOR RECTANGULAR WORK TABLES (DESKTOP 36mm THICK)

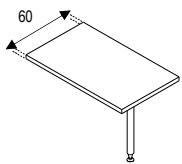
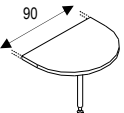
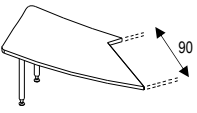
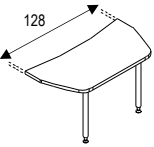
9041 E		WL NE E	100 cm	Pravokutni dodatak 9041 E dimenzije 100x60x74h cm s okruglom metalnom kromiranom nogom <i>Rectangular end 9041 E dimensions 100x60x74h cm with rounded metal chrome leg</i>	1 x 9041 E	18
			60 cm		0,0639	
			74 cm		2	
9042 E		WL NE E	65 cm	Zaobljeni dodatak 9042 E dimenzije 65x90x74h cm s okruglom metalnom kromiranom nogom <i>Rounded end 9042 E dimensions 65x90x74h cm with rounded metal chrome leg</i>	1 x 9042 E	17
			90 cm		0,0734	
			74 cm		2	
9043L E 9043D E		WL NE E	190 cm	Dodatak 9043 E dimenzije 190x75x73,1h cm (sa 2 okrugle metalne kromirane noge) za radni stol <i>Shaped end 9043 E dimensions 190x75x73,1h cm (with 2 round metal chrome legs) for work table</i>	1 x 9043(L/D) E	26
			75 cm		0,1075	
			73,1 cm		3	
9044 E		WL NE E	128 cm	Dodatak 9044 E dimenzije 128x70x73,1h cm (sa 2 okrugle metalne kromirane noge) za zaobljeni radni stol 9003 <i>Shaped end 9044 E dimensions 128x70x73,1h cm (with 2 round metal chrome legs) for work rounded table 9003</i>	1 x 9044 E	27
			70 cm		0,0616	
			73,1 cm		3	

NEXUS ECONOMY drvene noge / NEXUS ECONOMY melamine legs

ZAJEDNIČKA OZNAKA	SLIKA	IZBOR BOJA	DIM.(cm) š d v	OPIS	SASTAV	PAK. kg m3 paketa
ARTICLE CODE	PICTURE	COLOUR SELECTION	DIM.(cm) w d h	DESCRIPTION	ASSEMBLY	PACK. kg m3 col

KONFERENCIJSKI STOLOVI I KLUB STOLIĆI CONFERENCE TABLES AND TABLES FOR WAITING ROOM

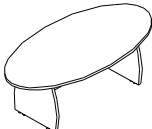
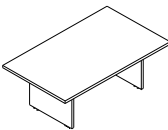
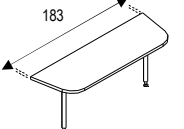
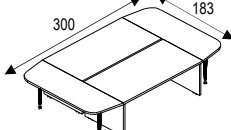
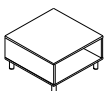
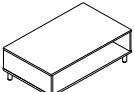
9071 E		WL NE E	210 cm	Zaobljeni konferencijski stol 9071 E dimenzije 210x105x74h cm s drvenim nogama - top 36mm	1 x 9071 E	93
			105 cm	Rounded work table 9071 E dimensions 210x105x74h cm with wooden legs - top 36mm		0,252
			74 cm			2
9072 E		WL NE E	200 cm	Pravokutni konferencijski stol 9072 E dimenzije 200x120x74h cm s drvenim nogama - top 36mm	1 x 9072 E	103
			120 cm	Rectangular conference table 9072 E dimensions 200x120x74h cm with wooden legs - top 36mm		0,288
			74 cm			2
9141 E		WL CH NE	183 cm	Dodatak 9141 E dimenzije 183x60x74h cm (sa 2 okrugle metalne kromirane noge) - za stolove	1 x 9141 E	32
			60 cm	Shaped end 9141 E dimensions 183x60x74h cm (with 2 round metal chrome legs)		0,0787
			74 cm			3
9938 E		WL CH NE	300 cm	Kompozicija konf.stola 9938 E dimenzije 300x183x74h cm	2 x 9001 E*	172
			183 cm		2 x 9141 E	0,4508
			74 cm	Composition conf.table 9938 E dimensions 300x183x74h cm		12
9073 E		WL NE E	60 cm	Kvadratni klub stolić 9073 E dimenzije 60x60x35h cm na metalnim kromiranim nogama - top 18mm	1 x 9073 E	13
			60 cm	Square table for waiting room 9073 E dimensions 60x60x35h cm with metal chrome legs - top 18mm		0,169
			35 cm			2
9074 E		WL NE E	100 cm	Kvadratni klub stolić 9074 E dimenzije 100x60x35h cm na metalnim kromiranim nogama - top 18mm	1 x 9074 E	20
			60 cm	Square table for waiting room 9074 E dimensions 100x60x35h cm with metal chrome legs - top 18mm		0,273
			35 cm			2

LADIČARI CHEST OF DRAWERS

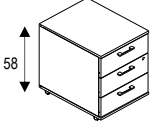
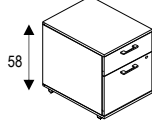
9501 E		WL NE E	43 cm	Pokretna kazeta 9501 E dimenzije 43x55x58h cm s 3 drvene ladicice i dodatnom ladicom za pisaci pribor dimenzije 43x55x58h cm	1 x 9501 E	20
			55 cm	Chest of drawers 9501 dimensions 43x55x58h cm with 3 wooden drawers and additional pen tray		0,1521
			58 cm			1
9502 E		WL NE E	43 cm	Pokretna kazeta za viseće mape 9502 E dimenzije 43x55x58h cm s 1 drvenom ladicom + dodatnom ladicom za pisaci pribor i 1 ladicom za viseće mape	1 x 9502 E	20
			55 cm	Filing chest of drawers 9502 E dimensions 43x55x58h cm with 1 wooden drawer + additional pen tray and 1 filing drawer		0,1521
			58 cm			1

NEXUS ECONOMY drvene noge / NEXUS ECONOMY melamine legs

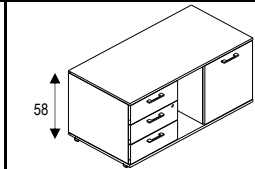
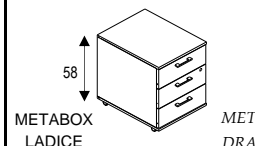
ZAJEDNIČKA OZNAKA	SLIKA	IZBOR BOJA	DIM.(cm) š d v	OPIS	SASTAV	PAK. kg m3 paketa
ARTICLE CODE	PICTURE	COLOUR SELECTION	DIM.(cm) w d h	DESCRIPTION	ASSEMBLY	PACK. kg m3 col
9503L E 9503D E		WL NE E	110 cm	Mobilni element 9503 E dimenzije 110x57x58h cm s 3 drvene ladice, ladicom za pisači pribor i drv. vratima (lijevi ili desni), ladice s lijeve ili desne strane	1 x 9503(L/D) E	42
			57 cm	Side table on castors 9503 E dimensions 110x57x58h cm with 3 wooden drawers, additional pen tray and wooden doors (left or right), drawers on left or right side		0,3636
			58 cm			1
9504 E		WL NE E	43 cm	Pokretna kazeta 9504 E dimenzije 43x55x58h cm s 3 metabox ladice i dodatnom ladicom za pisači pribor	1 x 9504 E	21
			55 cm	Chest of drawers 9504 E dimensions		0,1521
			58 cm	43x55x58h cm with 3 metabox drawers and additional pen tray		1

PRIMJERI SLOŽENIH KOMPOZICIJA GDJE JE GLAVNI RADNI STOL DUŽINE 180 cm ili 200 cm i širine 90 cm ili 95 cm.

(u slučaju potrebe izmjeniti u specifikaciji šifru glavnog stola, moguće dužine 180 cm ili 200 cm za širinu 90cm)*

EXAMPLES OF COMPOSITIONS WITH THE MAIN DESK IN LENGTH 180 cm or 200 cm and depth 90 cm or 95 cm.

*(in case of different dimensions please change the code of main desk in the specification of composition, another available lengths are 180 cm or 200 cm for depth 90 cm or 95 cm)**

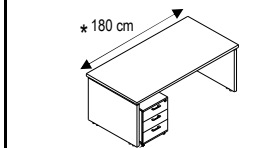
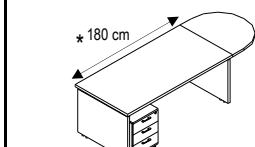
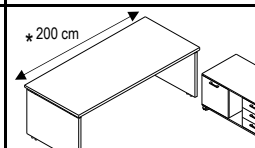
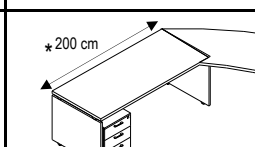
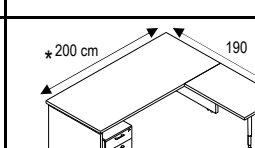
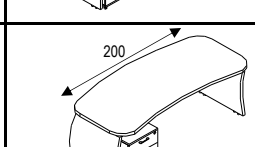
9930 E		WL NE E	180 cm	Kompozicija 9930 E dimenzije 180x90x74h cm za 1 radno mjesto	1 x 9001 E*	100
			90 cm		1 x 9501 E	0,333
			74 cm	Composition 9930 E dimensions 180x90x74h cm for 1 workplace		3
9931 E		WL NE E	245 cm	Kompozicija 9931 E dimenzije 245x90x74h cm za 1 radno mjesto	1 x 9001 E*	117
			90 cm		1 x 9042 E	0,4064
			74 cm	Composition 9931 E dimensions 245x90x74h cm for 1 workplace	1 x 9501 E	5
9932 E		WL NE E	200 cm	Kompozicija 9932 E dimenzije 200x205x74h cm za 1 radno mjesto	1 x 9002 E*	131
			205 cm		1 x 9503D E	0,5479
			74 cm	Composition 9932 E dimensions 200x205x74h cm for 1 workplace		3
9933 E		WL NE E	250 cm	Kompozicija 9933 E dimenzije 250x190x74h cm za 1 radno mjesto	1 x 9002 E*	135
			190 cm		1 x 9043D E	0,4439
			74 cm	Composition 9933 E dimensions 250x190x74h cm for 1 workplace	1 x 9501 E	6
9934 E		WL NE E	200 cm	Kompozicija 9934 E dimenzije 200x190x74h cm za 1 radno mjesto	1 x 9002 E*	127
			190 cm		1 x 9041 E	0,4003
			74 cm	Composition 9934 E dimensions 200x190x74h cm for 1 workplace	1 x 9501 E	5
9935 E		WL NE E	200 cm	Kompozicija 9935 E dimenzije 200x95x74h cm za 1 radno mjesto	1 x 9003 E	111
			95 cm		1 x 9501 E	0,3564
			74 cm	Composition 9935 E dimensions 200x95x74h cm for 1 workplace		3

NEXUS ECONOMY drvene noge / NEXUS ECONOMY melamine legs

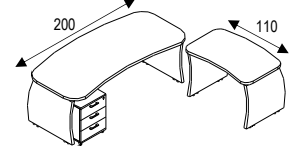
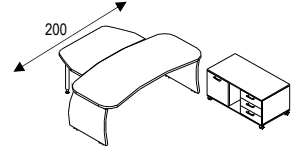
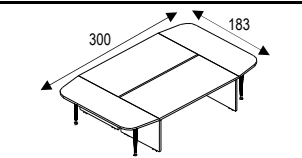

ZAJEDNIČKA OZNAKA	SLIKA	IZBOR BOJA	DIM.(cm) š d v	OPIS	SASTAV	PAK. kg m3 paketa
ARTICLE CODE	PICTURE	COLOUR SELECTION	DIM.(cm) w d h	DESCRIPTION	ASSEMBLY	PACK. kg m3 col
9936 E		WL NE E	200 cm	Kompozicija 9936 E dimenzije 200x205x74h cm za 1 radno mjesto <i>Composition 9936 E dimensions 200x205x74h cm for 1 workplace</i>	1 x 9003 E	159
			205 cm		1 x 9004 E	
			74 cm		1 x 9501 E	
9937 E		WL NE E	200 cm	Kompozicija 9937 E dimenzije 200x275x74h cm za 1 radno mjesto <i>Composition 9937 E dimensions 200x275x74h cm for 1 workplace</i>	1 x 9003 E	160
			275 cm		1 x 9044 E	
			74 cm		1 x 9503D E	
9938 E		WL CH NE	300 cm	Kompozicija konf.stola 9938 E dimenzije 300x183x74h cm <i>Composition conf.table 9938 E dimensions 300x183x74h cm</i>	2 x 9001 E*	172
			183 cm		2 x 9141 E	
			74 cm			
						12

NAPOMENA: SVAKA OD NAVEDENIH KOMPOZICIJA MOŽE SE NUDITI U RAZLIČITIM VELIČINAMA RADNIH STOLOVA. TAKOĐER MOGUĆE JE PROŠIRITI ILI SMANJITI PREDLOŽENE KOMPOZICIJE S TIME DA OBRATITE POZORNOST NA RASPOLOŽIVI PROSTOR.

REMARK: EACH COMPOSITION IS AVAILABLE IN DIFFERENT DIMENSIONS OF WORKTABLES. IT IS ALWAYS POSSIBLE TO EXPAND OR REDUCE SUGGESTED COMPOSITIONS BUT PLEASE TAKE ATTENTION TO AVAILABLE SPACE AT YOUR SITE.

OSTALI DODACI STOLOVIMA

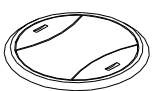
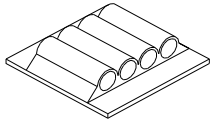
OTHER TABLE ACCESSORIES

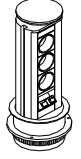
3094			6 cm	Držač za kablove 3094 dimenzije 6x6x0,5h cm, za sve radne i konferencijske stolove. Dostupna u crnoj, sivoj i bijeloj boji <i>Cable holder 3094 dimensions 6x6x0,5h cm, for all work and conference tables. Available in black, grey and white colour.</i>	1 x 3094	0,03
			6 cm			
			0.5 cm		1	
3095			8 cm	Držač za kablove 3094 dimenzije 6x6x0,5h cm, za sve radne i konferencijske stolove. Dostupna u crnoj, sivoj i bijeloj boji <i>Cable holder 3094 dimensions 6x6x0,5h cm, for all work and conference tables. Available in black, grey and white colour.</i>	1 x 3095	0,05
			4 cm			
			2 cm		1	
3096		RAL 9006	6 cm	Držač za kablove 3096 dimenzije 6x6x66-77h cm, za sve radne i konferencijske stolove s metalnim nogama. <i>Cable holder 3096 dimensions 6x6x66-77h cm, for all work and conference tables with metal legs.</i>	1 x 3096	1
			6 cm		0,0288	
			66-77 cm		1	
3097		RAL 9006	10 cm	Izvlačne utičnice 3097 dimenzije 10x10x38h cm, za sve radne i konferencijske stolove s metalnim nogama. <i>Electrical socket extension 3097 dimensions 10x10x38h cm, for all work and conference tables with metal legs.</i>	1 x 3097	1
			10 cm		0,0121	
			38 cm		1	

TEHNIČKI OPIS

TECHNICAL DESCRIPTION

STOLOVI

TABLES

Stolovi su izrađeni su iz melaminskih panela debljine 36 mm (ploča debljine 18 mm i pojačanje ispod ploče od 18 mm). Rubovi su kantirani ABS rubnom trakom debljine 2 mm zaobljenih rubova sa radiusom zaobljenja $r = 2$ mm.

Tables are made of 36mm thick chipboard melamine panels (chipboard top 18mm thick with reinforcement beneath 18mm thick), except connection panel which is 25mm thick . Edges are covered with 2mm thick ABS tape with rounded edges ($r=2$ mm).

DODACI STOLOVIMA

TABLE ENDS

Izrađeni su iz melaminskih panela debljine 36 mm (ploča debljine 18 mm i pojačanje ispod ploče od 18 mm). Uz topove dodataka u bojama isporučujemo kromirane metalne noge.

Table ends are made of melamine panels 36 mm thick (chipboard top 18mm thick with reinforcement beneath 18mm thick). For work table ends we are delivering chrome round metal legs.

LADIČARI

CHEST OF DRAWERS

Stranice, top, leđa i fronte ladica izrađeni su iz melaminskih panela debljine 18 mm, te kantirani ABS rubnom trakom. Ladice su od melaminskih panela debljine 12 mm (stranice ladica) i lakiranog MDF-a debljine 4 mm (dno ladice). Kazete su opremljene bravicom koja omogućava simultano zaključavanje svih ladica ("centralno zaključavanje"). Pokretne kazete opremljene su kotačima. Kompletna kazeta: leđa, završna ploča (top) i prednja ploča ladica (fronta) su u boji namještaja. Sve kazete dodatno su opremljene plastičnim ladicama za pisaći pribor. Posebno nudimo kazetu s metalnim metabox ladicama (9504).

Sides, top, back and drawer fronts are made of melamine panels 18mm thick with edges covered with ABS tape. Drawers are made of melamine panels 12mm thick (sides of drawer) and lacquered MDF 4mm thick (bottom of drawer). Chest of drawers is equipped with lock that enables simultaneous locking of all drawers ("central locking"). Movable chests of drawers are equipped with wheels. Complete drawer: back, frames, fronts and tops are made in colour of the furniture. All chest of drawers are additionaly equipped with pen tray. Especially we offer chest of drawers with metal metabox drawers (9504).

NAPOMENA U VEZI IZBORA BOJA

REMARK ABOUT COLOURS

Navedene boje u našoj ponudi su uvijek identične u svakoj isporuci. Međutim naziv (trešnja, javor i sl.) niti približno ne definira boju iverala. Na tržištu se mogu pojaviti stotine različitih varijacija pod oznakom npr. trešnja, a što je posljedica uzgoja ovog drveta u vrlo različitim klimatskim uvjetima. Isto tako i boje siva, antracit i sl. mogu se pojaviti u puno različitih nijansi. Zbog navedenog razloga na našim dostavnim dokumentima navodimo klauzulu: "Reklamaciju na vaš odabir boja nakon isporuke ne prihvaćamo".

Available colours in our assortment are identical in every delivery. However, the name (cherry, maple etc.) does not indicate the exact design. There are hundreds of different variations under the name for example cherry, which is caused by growing of cherry tree in different climate conditions. Uni colours like gray, anthracite etc. can also be in different designs. Due to above stated there is a remark on our delivery documentation: "After delivery, complaint on your selection of colours will not be accepted"

NEXUS ECONOMY ormari

NEXUS ECONOMY bookcases



BOJE - COLOURS

WL NE E

orah
walnut
SW 3A5





NEXUS ECONOMY ormar / NEXUS ECONOMY bookcases

ZAJEDNIČKA OZNAKA	SLIKA	IZBOR BOJA	DIM.(cm) š d v	OPIS	SASTAV	PAK. kg m3 paketa
ARTICLE CODE	PICTURE	COLOUR SELECTION	DIM.(cm) w d h	DESCRIPTION	ASSEMBLY	PACK. kg m3 col

ORMARI BEZ ZAVRŠNIH PLOČA ŠIRINE 90 cm, DUBINE 45cm, POLICE I LEĐA ORMARA SIVA SG 263



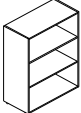
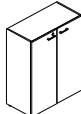
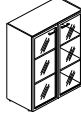
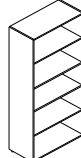
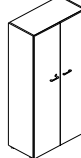

BOOKCASES WITHOUT TOPS WIDTH 90 cm, DEPTH 45 cm, SHELVES AND BACK SIDE COLOUR GREY SG 263

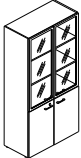
9601 E		WL NE E	90 cm	Niski otvoreni ormar 9601 E dimenzije 90x45x79,8h cm s 1 policom	1 x 9601 E	31
			45 cm	Open low bookcase 9601 E dimensions 90x45x79,8h cm with 1 shelf		0,0725
			79,8 cm			2
9602 E		WL NE E	90 cm	Niski ormar 9602 E dimenzije 90x45x79,8h cm s drvenim vratima s 1 policom i bravicom	1 x 9602 E	36
			45 cm	Low bookcase 9602 E dimensions 90x45x79,8h cm with wooden doors with 1 shelf and with lock		0,086
			79,8 cm			3
9603 E		WL NE E	90 cm	Niski ormar 9603 E dimenzije 90x45x79,8h cm s staklenim vratima s 1 policom bez brave	1 x 9603 E	40
			45 cm	Low bookcase 9603 E dimensions 90x45x79,8h cm with glass doors with 1 shelf without lock		0,0922
			79,8 cm			3
9611 E		WL NE E	90 cm	Srednji otvoreni ormar 9611 E dimenzije 90x45x121,6h cm s 2 police	1 x 9611 E	51
			45 cm	Open medium bookcase 9611 E dimensions 90x45x121,6h cm with 2 shelves		0,1425
			121,6 cm			2
9612 E		WL NE E	90 cm	Srednji ormar 9612 E dimenzije 90x45x121,6h cm s drvenim vratima s 2 police i bravicom	1 x 9612 E	68
			45 cm	Medium bookcase 9612 E dimensions 90x45x121,6h cm with wooden doors with 2 shelves and with lock		0,1811
			121,6 cm			3
9613 E		WL NE E	90 cm	Srednji ormar 9613 E dimenzije 90x45x121,6h cm s staklenim vratima s 2 police bez brave	1 x 9613 E	65
			45 cm	Medium bookcase 9613 E dimensions 90x45x121,6h cm with glass doors with 2 shelves without lock		0,1775
			121,6 cm			3
9621 E		WL NE E	90 cm	Visoki otvoreni ormar 9621 E dimenzije 90x45x201,4h cm s 4 police	1 x 9621 E	71
			45 cm	Open high bookcase 9621 E dimensions 90x45x201,4h cm with 4 shelves		0,1625
			201,4 cm			2
9622 E		WL NE E	90 cm	Visoki ormar 9622 E dimenzije 90x45x201,4h cm s drvenim vratima s 4 police i bravicom	1 x 9622 E	94
			45 cm	High bookcase 9622 E dimensions 90x45x201,4h cm with wooden doors with 4 shelves and with lock		0,2146
			201,4 cm			3

NEXUS ECONOMY ormar / NEXUS ECONOMY bookcases

ZAJEDNIČKA OZNAKA	SLIKA	IZBOR BOJA	DIM.(cm) š d v	OPIS	SASTAV	PAK. kg m3 paketa
ARTICLE CODE	PICTURE	COLOUR SELECTION	DIM.(cm) w d h	DESCRIPTION	ASSEMBLY	PACK. kg m3 col
9623 E		WL NE E	90 cm	Visoki ormar 9623 E dimenzije 90x45x201,4h cm s drvenim i staklenim vratima s 4 police i bravicom	1 x 9623 E	
			45 cm	<i>High bookcase 9623 E dimensions</i>		
			201,4 cm	<i>90x45x201,4h cm with wooden and glass doors with 4 shelves and with lock</i>		

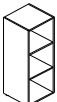
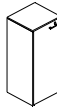
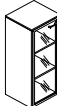
ORMARI BEZ ZAVRŠNIH PLOČA ŠIRINE 45 cm, DUBINE 45cm, POLICE I LEĐA ORMARA SIVA SG 263
BOOKCASES WITHOUT TOPS WIDTH 45 cm, DEPTH 45 cm, SHELVES AND BACK SIDE COLOUR GREY SG 263

9631 E		WL NE E	45 cm	Niski otvoreni ormar 9631 E dimenzije 45x45x79,8h cm s 1 policom	1 x 9631 E	19
			45 cm	<i>Open low bookcase 9631 E dimensions</i>		0,061
			79,8 cm	<i>45x45x79,8h cm with 1 shelf</i>		2
9632D E 9632L E		D WL NE E	45 cm	Niski ormar 9632 E dimenzije 45x45x79,8h cm s drvenim vratima s 1 policom i bravicom (lijevi ili desni)	1 x 9632(L/D) E	22
			45 cm	<i>Low bookcase 9632 E dimensions 45x45x79,8h cm with wooden doors with 1 shelf and with lock (left or right)</i>		0,131
			79,8 cm			3
9633D E 9633L E		D WL NE E	45 cm	Niski ormar 9633 E dimenzije 45x45x79,8h cm s staklenim vratima s 1 policom bez brave (lijevi ili desni)	1 x 9633(L/D) E	23
			45 cm	<i>Low bookcase 9633 E dimensions 45x45x79,8h cm with glass doors with 1 shelf without lock (left or right)</i>		0,0674
			79,8 cm			3
9641 E		WL NE E	45 cm	Srednji otvoreni ormar 9641 E dimenzije 45x45x121,6h cm s 2 police	1 x 9641 E	34
			45 cm	<i>Open medium bookcase 9641 E dimensions</i>		0,1178
			121,6 cm	<i>45x45x121,6h cm with 2 shelves</i>		2
9642L E 9642D E		L WL NE E	45 cm	Srednji ormar 9642 E dimenzije 45x45x121,6h cm s drvenim vratima s 2 police i bravicom (lijevi ili desni)	1 x 9642(L/D) E	43
			45 cm	<i>Medium bookcase 9642 E dimensions</i>		0,1379
			121,6 cm	<i>45x45x121,6h cm with wooden doors with 2 shelves and with lock (left or right)</i>		3
9643L E 9643D E		L WL NE E	45 cm	Srednji ormar 9643 E dimenzije 45x45x121,6h cm s staklenim vratima s 2 police bez brave (lijevi ili desni)	1 x 9643(L/D) E	42
			45 cm	<i>Medium bookcase 9643 E dimensions</i>		0,1363
			121,6 cm	<i>45x45x121,6h cm with glass doors with 2 shelves without lock (left or right)</i>		3
9651 E		WL NE E	45 cm	Visoki otvoreni ormar 9651 E dimenzije 45x45x201,4h cm s 4 police	1 x 9651 E	46
			45 cm	<i>Open high bookcase 9651 E dimensions</i>		0,188
			201,4 cm	<i>45x45x201,4h cm with 4 shelves</i>		2

NEXUS ECONOMY ormani / NEXUS ECONOMY bookcases

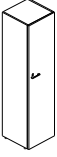
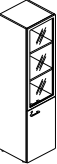
ZAJEDNIČKA OZNAKA	SLIKA	IZBOR BOJA	DIM.(cm) š d v	OPIS	SASTAV	PAK. kg m3 paketa
ARTICLE CODE	PICTURE	COLOUR SELECTION	DIM.(cm) w d h	DESCRIPTION	ASSEMBLY	PACK. kg m3 col
9652L E 9652D E	 D	WL NE E	45 cm	Visoki ormar 9652 E dimenzije 45x45x201,4h cm s drvenim vratima s 4 police i bravicom (lijevi ili desni)	1 x 9652(L/D) E	58
			45 cm	<i>High bookcase 9652 E dimensions</i>		0,215
			201,4 cm	<i>45x45x201,4h cm with wooden doors with 4 shelves and with lock (left or right)</i>		3
9653L E 9653D E	 D	WL NE E	45 cm	Visoki ormar 9653 E dimenzije 45x45x201,4h cm s drvenim i staklenim vratima s 4 police i bravicom	1 x 9653(L/D) E	
			45 cm	<i>High bookcase 9653 E dimensions</i>		
			201,4 cm	<i>45x45x201,4h cm with wooden and glass doors with 4 shelves and with lock</i>		

ZAVRŠNE PLOČE ORMARA ŠIRINE 45 i 90 cm

TOPS FOR BOOKCASES WIDTH 45 AND 90 cm

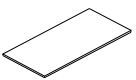
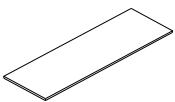
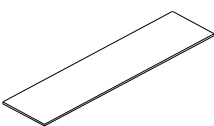
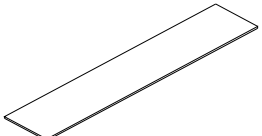
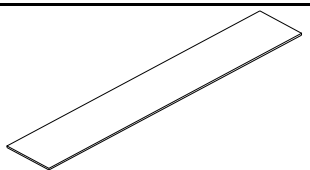

9671 E		WL NE E	45 cm	Završna ploča ormara za 1 krilo 9671 E dimenzije 45x45x3,6h cm za ormare širine 45 i 90 cm	1 x 9671 E	3
			45 cm	<i>Top for bookcase for 1 door 9671 E dimensions</i>		0,0055
			3,6 cm	<i>45x45x3,6h cm for bookcases lenght 45 and 90 cm</i>		1
9672 E		WL NE E	90 cm	Završna ploča ormara za 2 krila 9672 E dimenzije 90x45x3,6h cm za ormare širine 45 i 90 cm	1 x 9672 E	6
			45 cm	<i>Top for bookcase for 2 doors 9672 E dimensions 90x45x3,6h cm for bookcases</i>		0,0103
			3,6 cm	<i>lenght 45 and 90 cm</i>		1
9673 E		WL NE E	135 cm	Završna ploča ormara za 3 krila 9673 E dimenzije 135x45x3,6h cm za ormare širine 45 i 90 cm	1 x 9673 E	9
			45 cm	<i>Top for bookcase for 3 doors 9673 E dimensions 135x45x3,6h cm for bookcases</i>		0,0156
			3,6 cm	<i>lenght 45 and 90 cm</i>		1
9674 E		WL NE E	180 cm	Završna ploča ormara za 4 krila 9674 E dimenzije 180x45x3,6h cm za ormare širine 45 i 90 cm	1 x 9674 E	12
			45 cm	<i>Top for bookcase for 4 doors 9674 E dimensions 180x45x3,6h cm for bookcases</i>		0,0205
			3,6 cm	<i>lenght 45 and 90 cm</i>		1
9675 E		WL NE E	225 cm	Završna ploča ormara za 5 krila 9675 E dimenzije 225x45x3,6h cm za ormare širine 45 i 90 cm	1 x 9675 E	15
			45 cm	<i>Top for bookcase for 5 doors 9675 E dimensions 225x45x3,6h cm for bookcases</i>		0,0251
			3,6 cm	<i>lenght 45 and 90 cm</i>		1
9676 E		WL NE E	270 cm	Završna ploča ormara za 6 krila 9676 E dimenzije 270x45x3,6h cm za ormare širine 45 i 90 cm	1 x 9676 E	18
			45 cm	<i>Top for bookcase for 6 doors 9676 E dimensions 270x45x3,6h cm for bookcases</i>		0,0301
			3,6 cm	<i>lenght 45 and 90 cm</i>		1

NEXUS ECONOMY ormari / NEXUS ECONOMY bookcases



ZAJEDNIČKA OZNAKA	SLIKA	IZBOR BOJA	DIM.(cm) š d v	OPIS	SASTAV	PAK. kg m3 paketa
ARTICLE CODE	PICTURE	COLOUR SELECTION	DIM.(cm) w d h	DESCRIPTION	ASSEMBLY	PACK. kg m3 col

PRIMJERI SLOŽENIH KOMPOZICIJA ORMARA ŠIRINE 90 i 45 cm - DODANE SU ZAVRŠNE PLOČE

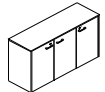
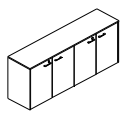
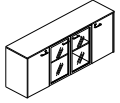
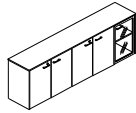
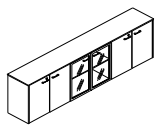
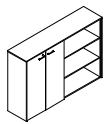
EXAMPLE OF ASSEMBLED COMPOSITIONS BOOKCASES WIDTH 90 AND 45 cm - TOPS ARE ADDED ACCORDINGLY

9901 E		WL NE E	94 cm	Kompozicija ormara 9901 E dimenzije 94x45x83,4h cm <i>Composition of bookcases 9901 E dimensions 94x45x83,4h cm</i>	1 x 9601 E	49
			45 cm		1 x 9672 E	
			83,4 cm		0,1079	
9902 E		WL NE E	94 cm	Kompozicija ormara 9902 E dimenzije 94x45x83,4h cm <i>Composition of bookcases 9902 E dimensions 94x45x83,4h cm</i>	1 x 9603 E	58
			45 cm		1 x 9672 E	
			83,4 cm		0,1276	
9903 E		WL NE E	139 cm	Kompozicija ormara 9903 E dimenzije 139x45x83,4h cm <i>Composition of bookcases 9903 E dimensions 139x45x83,4h cm</i>	1 x 9602 E	79
			45 cm		1 x 9632D E	
			83,4 cm		1 x 9673 E	
9904 E		WL NE E	184 cm	Kompozicija ormara 9904 E dimenzije 184x45x83,4h cm <i>Composition of bookcases 9904 E dimensions 184x45x83,4h cm</i>	2 x 9602 E	96
			45 cm		1 x 9674 E	
			83,4 cm		0,2176	
9905 E		WL NE E	184 cm	Kompozicija ormara 9905 E dimenzije 184x45x83,4h cm <i>Composition of bookcases 9905 E dimensions 184x45x83,4h cm</i>	1 x 9603 E	108
			45 cm		1 x 9632L E	
			83,4 cm		1 x 9632D E	
9906 E		WL NE E	184 cm	Kompozicija ormara 9906 E dimenzije 229x45x83,4h cm <i>Composition of bookcases 9906 E dimensions 229x45x83,4h cm</i>	1 x 9674 E	0,3998
			45 cm		1 x 9675 E	
			83,4 cm		11	
9907 E		WL NE E	229 cm	Kompozicija ormara 9907 E dimenzije 274x45x83,4h cm <i>Composition of bookcases 9907 E dimensions 274x45x83,4h cm</i>	2 x 9602 E	142
			45 cm		1 x 9603 E	
			83,4 cm		1 x 9676 E	
9908 E		WL NE E	274 cm	Kompozicija ormara 9908 E dimenzije 184x45x125,2h cm <i>Composition of bookcases 9908 E dimensions 184x45x125,2h cm</i>	1 x 9611 E	147
			45 cm		1 x 9612 E	
			125,2 cm		1 x 9674 E	
						0,3816
						7

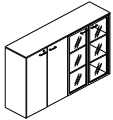
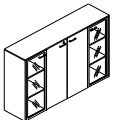
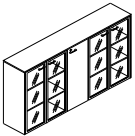
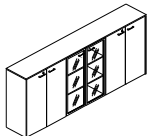
NEXUS ECONOMY ormani / NEXUS ECONOMY bookcases

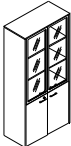
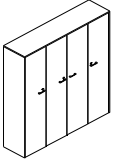
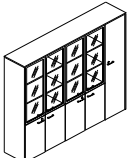
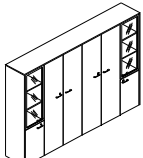
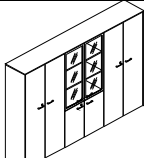
ZAJEDNIČKA OZNAKA	SLIKA	IZBOR BOJA	DIM.(cm) š d v	OPIS	SASTAV	PAK. kg m3 paketa
ARTICLE CODE	PICTURE	COLOUR SELECTION	DIM.(cm) w d h	DESCRIPTION	ASSEMBLY	PACK. kg m3 col
9909 E		WL NE E	184 cm	Kompozicija ormara 9909 E dimenzije 184x45x125,2h cm	1 x 9612 E	161
			45 cm		1 x 9613 E	
			125,2 cm	Composition of bookcases 9909 E dimensions 184x45x125,2h cm	1 x 9674 E	0,4166
						8
9910 E		WL NE E	184 cm	Kompozicija ormara 9910 E dimenzije 184x45x125,2h cm	1 x 9612 E	180
			45 cm		1 x 9643L E	
			125,2 cm	Composition of bookcases 9910 E dimensions 184x45x125,2h cm	1 x 9643D E	0,5117
						11
9911 E		WL NE E	229 cm	Kompozicija ormara 9911 E dimenzije 229x45x125,2h cm	2 x 9613 E	204
			45 cm		1 x 9642D E	
			125,2 cm	Composition of bookcases 9911 E dimensions 229x45x125,2h cm	1 x 9675 E	0,5556
						11
9912 E		WL NE E	274 cm	Kompozicija ormara 9912 E dimenzije 274x45x125,2h cm	2 x 9612 E	235
			45 cm		1 x 9613 E	
			125,2 cm	Composition of bookcases 9912 E dimensions 274x45x125,2h cm	1 x 9676 E	0,6073
						11
9913 D E 9913 L E		WL NE E	45 cm	Kompozicija ormara 9913 E dimenzije 45x45x205h cm	1 x 9653D E	94
			45 cm		1 x 9671 E	
			205 cm	Composition of bookcases 9913 E dimensions 45x45x205 cm		0,3353
						8
9914 E		WL NE E	90 cm	Kompozicija ormara 9914 E dimenzije 90x45x205h cm	1 x 9623 E	134
			45 cm		1 x 9672 E	
			205 cm	Composition of bookcases 9914 E dimensions 90x45x205 cm		0,3363
						8
9915 E		WL NE E	184 cm	Kompozicija ormara 9915 E dimenzije 184x45x205h cm	1 x 9622 E	249
			45 cm		1 x 9652L E	
			205 cm	Composition of bookcases 9915 E dimensions 184x45x205h cm	1 x 9652D E	0,7276
						11
9916 E		WL NE E	229 cm	Kompozicija ormara 9916 E dimenzije 229x45x205h cm	2 x 96232 E	302
			45 cm		1 x 9652D E	
			205 cm	Composition of bookcases 9916 E dimensions 229x45x205h cm	1 x 9675 E	0,8296
						17
9917 E		WL NE E	274 cm	Kompozicija ormara 9917 E dimenzije 274x45x205h cm	2 x 9622 E	361
			45 cm		1 x 9653L E	
			205 cm	Composition of bookcases 9917 E dimensions 274x45x205h cm	1 x 9653D E	1,0564
						20
9918 E		WL NE E	274 cm	Kompozicija ormara 9918 E dimenzije 274x45x205h cm	2 x 9622 E	334
			45 cm		1 x 9623 E	
			205 cm	Composition of bookcases 9918 E dimensions 274x45x205h cm	1 x 9676 E	0,7853
						14

NEXUS ECONOMY ormar i / NEXUS ECONOMY bookcases

ZAJEDNIČKA OZNAKA	SLIKA	IZBOR BOJA	DIM.(cm) š d v	OPIS	SASTAV	PAK. kg m3 paketa
ARTICLE CODE	PICTURE	COLOUR SELECTION	DIM.(cm) w d h	DESCRIPTION	ASSEMBLY	PACK. kg m3 col

ORMARI ŠIRINE 100 cm, DUBINE 45 cm, PREDVIĐENI ZA FORMIRANJE KOMODA, POLICE I LEĐA ORMARA SIVA SG 263

BOOKCASES WIDTH 100 cm, DEPTH 45 cm, USED FOR ASSEMBLING BOOKCASES, SHELVES AND BACK SIDE COLOUR GREY SG 263

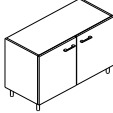
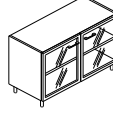
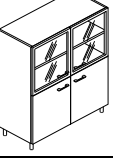
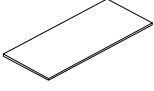
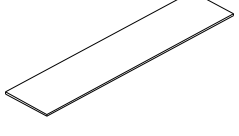
9701 E		WL NE E	100 cm	Ormar 9701 E dimenzije 100x45x60h cm s drvenim vratima s 1 policom i bravicom, bez topa	1 x 9701 E	35
			45 cm	<i>Bookcase 9701 E dimensions 100x45x60h cm with wooden doors with 1 shelf and with lock, without top</i>		0,086
			70 cm			3
9702 E		WL NE E	100 cm	Ormar 9702 E dimenzije 100x45x60h cm s staklenim vratima s 1 policom bez brave i topa	1 x 9702 E	39
			45 cm	<i>Bookcase 9702 E dimensions 100x45x70h cm with glass doors with 1 shelf without lock and top</i>		0,0922
			70 cm			3
9704 E		WL NE E	100 cm	Ormar 9704 E dimenzije 100x45x130h cm s drvenim i staklenim vratima s 3 police bez brave i topa	1 x 9704 E	74
			45 cm	<i>Bookcase 9704 E dimensions 100x45x130h cm with wooden and glass doors with 3 shelves without lock and top</i>		0,1782
			130 cm			3
9771 E		WL NE E	100 cm	Završna ploča komode za 2 krila 9771 E dimenzije 100x45x3,6h cm za komode širine 100 cm	1 x 9771 E	7
			45 cm	<i>Top for bookcase for 2 doors 9771 E dimensions 100x45x3,6h cm for bookcases lenght 100 cm</i>		0,0113
			3,6 cm			1
9772 E		WL NE E	200 cm	Završna ploča komode za 4 krila 9772 E dimenzije 200x45x3,6h cm za komode širine 100 cm	1 x 9772 E	13
			45 cm	<i>Top for bookcase for 4 doors 9772 E dimensions 200x45x3,6h cm for bookcases lenght 100 cm</i>		0,0221
			3,6 cm			1

KOMODE FORMIRANE OD ORMARA ŠIRINE 100 cm I DUBINE 45 cm - DODANE SU ZAVRŠNE PLOČE

BOOKCASES FORMED FROM PARTS OF BOOKCASES WIDTH 100 cm AND DEPTH 45 cm - TOPS ARE ADDED ACCORDINGLY

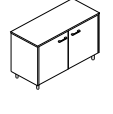
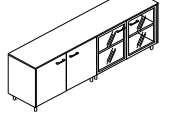

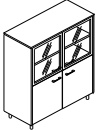
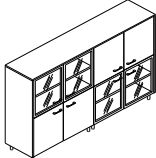

9919 E		WL NE E	100 cm	Kompozicija ormara 9919 E dimenzije 100x45x73,6h cm	1 x 9701 E	54
			45 cm			
			73,6 cm	<i>Composition of bookcases 9919 E dimensions 100x45x73,6h cm</i>		6
9920 E		WL NE E	200 cm	Kompozicija ormara 9920 E dimenzije 200x45x73,6h cm	1 x 9701 E	100
			45 cm			
			73,6 cm	<i>Composition of bookcases 9920 E dimensions 200x45x73,6h cm</i>	1 x 9702 E 1 x 9772 E	0,2163
						10

NEXUS ECONOMY ormari / NEXUS ECONOMY bookcases

ZAJEDNIČKA OZNAKA	SLIKA	IZBOR BOJA	DIM.(cm) š d v	OPIS	SASTAV	PAK. kg m3 paketa
ARTICLE CODE	PICTURE	COLOUR SELECTION	DIM.(cm) w d h	DESCRIPTION	ASSEMBLY	PACK. kg m3 col
9921 E		WL NE E	100 cm	Kompozicija ormara 9921 E dimenzije 100x45x133,6h cm	1 x 9704 E	96
			45 cm	<i>Composition of bookcases 9921 E dimensions</i> 100x45x133,6h cm	1 x 9771 E	
			133,6 cm		9	
9922 E		WL NE E	200 cm	Kompozicija ormara 9922 E dimenzije 200x45x133,6h cm	2 x 9704 E	177
			45 cm	<i>Composition of bookcases 9922 E dimensions</i> 200x45x133,6h cm	1 x 9772 E	
			133,6 cm		16	

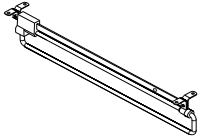
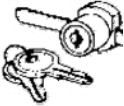
OSTALI DODACI ZA ORMARE I URED

ACCESSORIES FOR BOOKCASES AND OFFICE

A/HGR		CHROM	36 cm	Izvlačna vješalica za garderobni ormar dimenzije 36x4x6h cm	1 x A/HGR	0,4
			4 cm	<i>Extension hanger for wardrobe dimensions</i> 36x4x6h cm		0,001
			6 cm		1	
A/LCKS		CHROM	2 cm	Bravica za sva staklena vrata ormara dimenzije 2x2x4h cm	1 x A/LCKS	0,2
			2 cm	<i>Lock for all glass doors dimensions 2x2x4h cm</i>		0,0001
			4 cm		1	
SVB		CRNA	56 cm	Samostojeća vješalica GIR CRNA dimenzije 56x56x175h cm	1 x SVB	5
			56 cm	<i>Wardrobe hanger GIR BLACK dimensions</i> 56x56x175h cm		0,0296
			175 cm		1	
SVC		CHROM	56 cm	Samostojeća vješalica GIR CHROM dimenzije 56x56x175h cm	1 x SVC	5
			56 cm	<i>Wardrobe hanger GIR CHROM</i> dimensions 56x56x175h cm		0,0296
			175 cm		1	
KZS		CRNA	28 cm	Koš za smeće žičani dimenzije Ø28x35h cm	1 x KZS	0,5
			28 cm	<i>Trash basket dimensions</i> Ø28x35h cm		0,0361
			35 cm		1	

TEHNIČKI OPIS

TECHNICAL DESCRIPTION

ORMARI
BOOKCASES

Izrađeni su od melaminskih panela u debljinama kako slijedi: bočne stranice, vrata i završna ploča 18 mm; police 25 mm. Svi rubovi ormara (uključujući i police) su kantirani ABS rubnom trakom. Police i leđa ormara su u sivoj boji, dok su vrata ormara, bočne stranice i završna ploča u boji namještaja. Ormari su opremljeni nožicama za regulaciju visine podesivim iznutra. Staklena vrata su debljine 5 mm. Drvena vrata standardno su opremljena sa bravicom, kod staklenih je to opcija. Kao opcije se mogu dobiti i dodatne police za ormar.

Bookcases are made of melamine panels in thickness as follows: side panels, fronts, tops and back side 18mm; shelves 25 mm. All edges of bookcase (including shelves) are covered with ABS tape. Shelves and back side are in gray colour, while the fronts, side panels and tops are made in colour of the furniture. Bookcases are equipped with legs for height regulation that are adjustable from the inside. Glass doors have thickness of 5mm. Wooden fronts are equipped with locks as standard, on glass doors lock is an option. Additional shelves can be delivered as option too.

NAPOMENA U VEZI IZBORA BOJA
REMARK ABOUT COLOURS

Navedene boje u našoj ponudi su uvijek identične u svakoj isporuci. Međutim naziv (trešnja, javor i sl.) niti približno ne definira boju iverala. Na tržištu se mogu pojaviti stotine različitih varijacija pod oznakom npr. trešnja, a što je posljedica uzgoja ovog drveta u vrlo različitim klimatskim uvjetima. Isto tako i boje siva, antracit i sl. mogu se pojaviti u puno različitih nijansi. Zbog navedenog razloga na našim dostavnim dokumentima navodimo klauzulu: "Reklamaciju na vaš odabir boja nakon isporuke ne prihvaćamo".

Available colours in our assortment are identical in every delivery. However, the name (cherry, maple etc.) does not indicate the exact design. There are hundreds of different variations under the name for example cherry, which is caused by growing of cherry tree in different climate conditions. Uni colours like gray, anthracite etc. can also be in different designs. Due to above stated there is a remark on our delivery documentation: "After delivery, complaint on your selection of colours will not be accepted"