



Pult metalne konstrukcije



Pult metalne konstrukcije



Pult drvene konstrukcije

PULTOVI

Boje

Iverali debljine 25 i 18 mm za
pultove metalne i drvene konstrukcije



Svijetli javor
SLM 723



Javor
SM 042



Siva
SG 263



Trešnja
SCH 323



Bijela
SWH 818120



Bukva
SBE 83B



Trešnja
SCH 8H7



Svijetli hrast
SLO RNX47

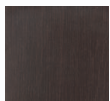

Tamni hrast
SDO ASL9



Trešnja
SCH 8R6



Trešnja
SCH 5A6



Orah
SW X70



Orah
SW 3A5



Orah
SW 4L8

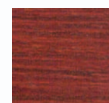

Crveni hrast

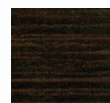

Tamni hrast



Izbjeljeni
hrast

artikli i tehnički opis programa PULTOVI

PULTOVI METALNE KONSTRUKCIJE

Elementi 60° konveksni

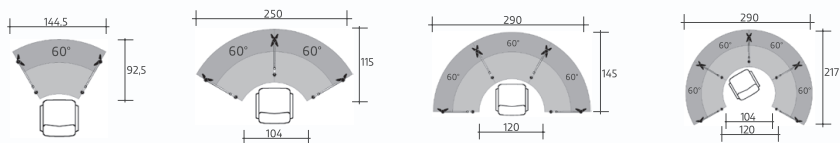

Elementi 45° konkavni

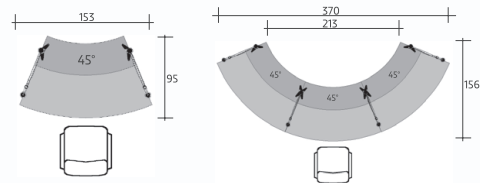

Elementi 60° konkavni

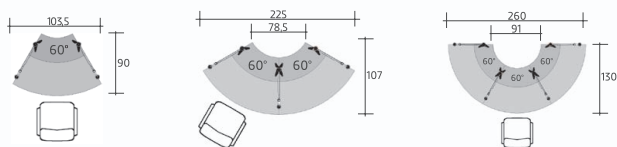

Elementi linearni dužine 100 cm i 200 cm

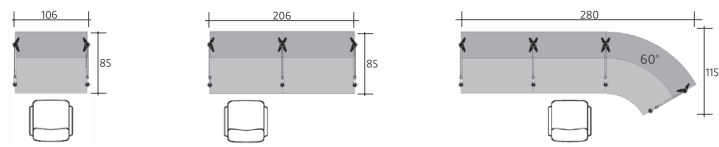

Primjeri slaganja raznih elemenata

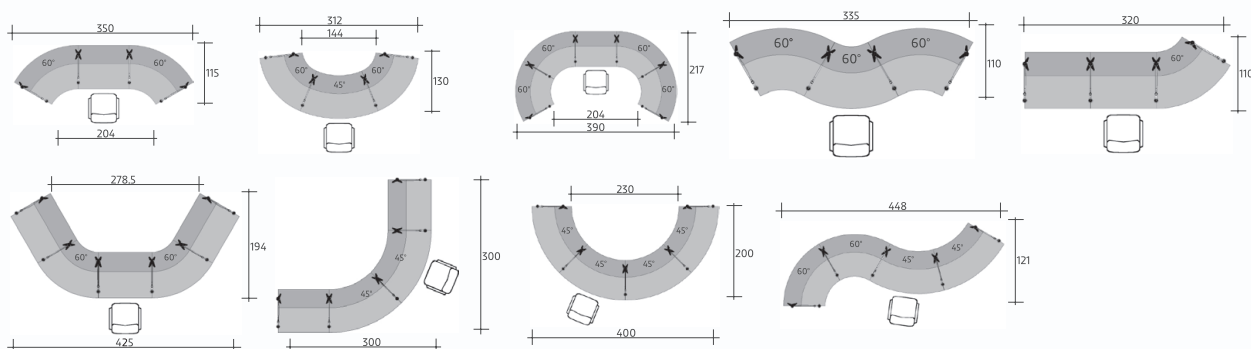

PULTOVI DRVENE KONSTRUKCIJE

Radni stol s pultom L. 120
302P, 120x87x110h

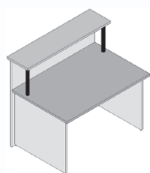

Radni stol s pultom L. 140
303P, 140x87x110h

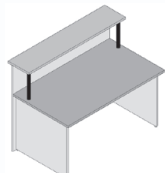

Radni stol s pultom L. 160
304P, 160x87x110h

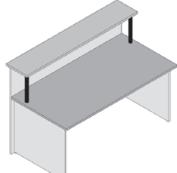

Otvoreni ormar s pultom
350P, 85x57x110h

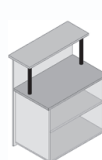

Ormar s drv. vratima s pultom
350P, 85x57x110h

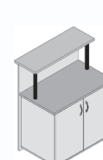

Unutarnji kutni dio pulta
KUT-U, 123x61x110h



Vanjski kutni dio pulta
KUT-V, 97x40x110h



Primjer složenog pulta
359x271x110h

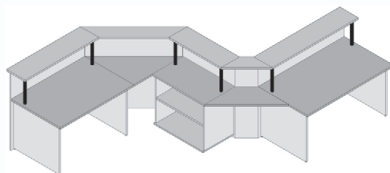

Primjer složenog pulta
247x172x110h

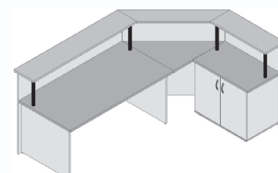

PULTOVI METALNE KONSTRUKCIJE

Završne ploče tj. topovi izrađeni su od iverala debljine 25 ili 30 mm. Rubovi su kantirani ABS rubnom trakom debljine 2 mm, zaobljenih rubova sa radijusom $r=2$ mm. Gornje ploče je osim od iverala moguće izvesti i u satiniranom staklu debljine 12 mm. Metalne noge i prednja fronta su lakirani u svojoj boji. Linearni elementi dužine 100 i 200 cm mogu se kombinirati sa konveksnim i konkavnim kutnim elementima od 45° i 60°. Na ovaj način mogu se složiti brojne kombinacije pultova.

PULTOVI DRVENE KONSTRUKCIJE

Svi dijelovi pulta osim metalnog potpornog stupića su od iverala. Završne ploče i noge pulta su debljine 25 mm, dok su prednje ploče i vrata debljine 18 mm. Rubovi su kantirani rubnom trakom debljine 2 mm, zaobljenih rubova sa radijusom $r=2$ mm. Metalni potporni stupići su lakirani u crnu boju. Linearni elementi dužine od 85 do 160 cm mogu se kombinirati sa unutrašnjim i vanjskim kutnim dijelom pulta, čime se mogu složiti brojne konfiguracije pultova.