

Program PULTOVI (drvene i metalne konstrukcije)

RECEPTIONS (melamine and metal construction)



BOJE - COLOURS

Iverali debljine 25mm za
pultove metalne i drvene konstrukcije
*melamine panels 25mm thick for
reception metal and melamine construction)*

Iverali debljine 30mm za
pultove metalne konstrukcije
*melamine panels 30mm thick for
reception metal construction)*

G	M	CH TR	LM	WH	R Sb
siva <i>grey</i> SG 263	javor <i>maple</i> SM 042	trešnja <i>cherry</i> SCH 323	svijetli javor <i>light maple</i> SLM 723	bijela <i>white</i> SWH 818 120	svijetli hrast <i>light oak</i> R Sb
SB	SW TR E	CH TR E	LO	DO	R W
bukva <i>beech</i> SBE 83B	orah <i>walnut</i> SW 4L8	trešnja <i>cherry</i> SCH 8H7	svijetli hrast <i>light oak</i> SLO RNX47	tamni hrast <i>dark oak</i> SDO A5L9	tamni hrast <i>dark oak</i> R W
TE CH	WL	CH NE	WL NE E	R Ro	
trešnja <i>cherry</i> SCH 8R6	orah <i>walnut</i> SW X70	trešnja <i>cherry</i> SCH 5A6	orah <i>walnut</i> SW 3A5	crveni hrast <i>red oak</i> R Ro	





Program PULTOVI (drvene i metalne konstrukcije) / RECEPTIONS (melamine and metal construction)

ZAJEDNIČKA OZNAKA	SLIKA	IZBOR BOJA	DIM.(cm) š d v	OPIS	SASTAV	PAK. kg m3 paketa
ARTICLE CODE	PICTURE	COLOUR SELECTION	DIM.(cm) w d h	DESCRIPTION	ASSEMBLY	PACK. kg m3 col

**ELEMENTI ZA KOMPOZICIJE PULTOVA DRVENE KONSTRUKCIJE
(DEBLJINA TOPOVA 25 mm)**

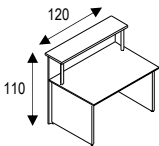
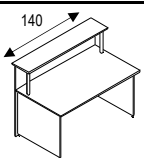
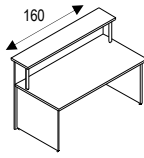
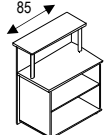
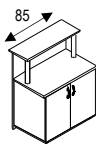
RECEPTION COMPOSITION ELEMENTS - WOODEN CONSTRUCTION (DESKTOP 25 mm THICK)

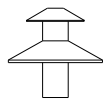
5001		G, M, CH TR, LM, WH, SB, SW TR E, CH TR E, LO, DO, TE CH, WL, CH NE, WL NE E	120 cm	Pult 5001 dimenzije 120x87x110h cm drvene konstrukcije <i>Reception 5001 dimensions 120x87x110h cm wooden construction</i>	1 x 5001	69
			87 cm			0,1159
			110 cm			3
5002		G, M, CH TR, LM, WH, SB, SW TR E, CH TR E, LO, DO, TE CH, WL, CH NE, WL NE E	140 cm	Pult 5002 dimenzije 140x87x110h cm drvene konstrukcije <i>Reception 5002 dimensions 140x87x110h cm wooden construction</i>	1 x 5002	78
			87 cm			0,1231
			110 cm			3
5003		G, M, CH TR, LM, WH, SB, SW TR E, CH TR E, LO, DO, TE CH, WL, CH NE, WL NE E	160 cm	Pult 5003 dimenzije 160x87x110h cm drvene konstrukcije <i>Reception 5003 dimensions 160x87x110h cm wooden construction</i>	1 x 5003	87
			87 cm			0,1303
			110 cm			3
5004		G, M, CH TR, LM, WH, SB, SW TR E, CH TR E, LO, DO, TE CH, WL, CH NE, WL NE E	85 cm	Pult 5004 dimenzije 85x57x110h cm drvene konstrukcije <i>Reception 5004 dimensions 85x57x110h cm wooden construction</i>	1 x 5004	51
			57 cm			0,1015
			110 cm			3
5005		G, M, CH TR, LM, WH, SB, SW TR E, CH TR E, LO, DO, TE CH, WL, CH NE, WL NE E	85 cm	Pult 5005 dimenzije 85x57x110h cm drvene konstrukcije <i>Reception 5005 dimensions 85x57x110h cm wooden construction</i>	1 x 5005	60
			57 cm			0,1015
			110 cm			4
5011		G, M, CH TR, LM, WH, SB, SW TR E, CH TR E, LO, DO, TE CH, WL, CH NE, WL NE E	123 cm	Pult 5011 dimenzije 123x61x110h cm drvene konstrukcije <i>Reception 5011 dimensions 123x61x110h cm wooden construction</i>	1 x 5011	36
			61 cm			0,1231
			110 cm			3
5012		G, M, CH TR, LM, WH, SB, SW TR E, CH TR E, LO, DO, TE CH, WL, CH NE, WL NE E	97 cm	Pult 5012 dimenzije 97x40x110h cm drvene konstrukcije <i>Reception 5012 dimensions 97x40x110h cm wooden construction</i>	1 x 5012	19
			40 cm			0,1231
			110 cm			3

Program PULTOVI (drvene i metalne konstrukcije) / RECEPTIONS (melamine and metal construction)

ZAJEDNIČKA OZNAKA	SLIKA	IZBOR BOJA	DIM.(cm) š d v	OPIS	SASTAV	PAK. kg m3 paketa
ARTICLE CODE	PICTURE	COLOUR SELECTION	DIM.(cm) w d h	DESCRIPTION	ASSEMBLY	PACK. kg m3 col

PRIMJERI SLOŽENIH KOMPOZICIJA PULTOVA DRVENE KONSTRUKCIJE
EXAMPLES OF RECEPTION COMPOSITIONS - WOODEN CONSTRUCTION









5901		G M CH TR LM WH SB SW TR E CH TR E LO DO TE CH WL CH NE WL NE E	247 cm	Kompozicija pulta 5901 dimenzije 247x172x110h cm	1 x 5003*	183
			172 cm		1 x 5011	
			110 cm		1 x 5005	
5902		G M CH TR LM WH SB SW TR E CH TR E LO DO TE CH WL CH NE WL NE E	359 cm	Kompozicija pulta 5902 dimenzije 359x271x110h cm	1 x 5001*	253
			271 cm		1 x 5002*	
			110 cm		1 x 5011 1 x 5012 1 x 5004	
5903		G M CH TR LM WH SB SW TR E CH TR E LO DO TE CH WL CH NE WL NE E	312 cm	Kompozicija pulta 5903 dimenzije 333x160x72h cm	1 x 5003*	435
			334 cm		2 x 5002*	
			110 cm		2 x 5011 2 x 5005	
				Reception composition 5901 dimensions 247x172x110h cm		0,3338
				Reception composition 5902 dimensions 359x271x110h cm		15
				Reception composition 5903 dimensions 333x160x72h cm		0,7958
						23

NAPOMENA: SVAKA OD NAVEDENIH KOMPOZICIJA MOŽE SE NUDITI U RAZLIČITIM VELIČINAMA PULTOVA. TAKOĐER MOGUĆE JE PROŠIRITI ILI SMANJITI PREDLOŽENE KOMPOZICIJE S TIME DA OBRATITE POZORNOST NA RASPOLOŽIVI PROSTOR
REMARK: EACH COMPOSITION IS AVAILABLE IN DIFFERENT DIMENSIONS OF RECEPTION ELEMENTS. IT IS ALWAYS POSSIBLE TO EXPAND OR REDUCE SUGGESTED COMPOSITIONS BUT PLEASE TAKE ATTENTION TO AVAILABLE SPACE AT YOUR SITE.

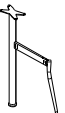



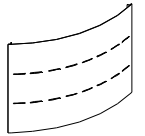

Program PULTOVI (drvene i metalne konstrukcije) / RECEPTIONS (melamine and metal construction)

ZAJEDNIČKA OZNAKA	SLIKA	IZBOR BOJA	DIM.(cm) š d v	OPIS	SASTAV	PAK. kg m3 paketa
ARTICLE CODE	PICTURE	COLOUR SELECTION	DIM.(cm) w d h	DESCRIPTION	ASSEMBLY	PACK. kg m3 col

ELEMENTI ZA KOMPOZICIJE PULTOVA METALNE KONSTRUKCIJE
RECEPTION COMPOSITION ELEMENTS- METAL CONSTRUCTION

5101 L (REC 103/G SX)		CHROM	6 cm	Završna lijeva metalna noga 5101 L dimenzije 6x61x100h cm lakirana u boju kroma	1 x 5101 L	6
			61 cm	Final left metal leg 5101L dimensions 6x61x100h cm chrome varnished		0,047
			100 cm			1
5101 D (REC 101/G DX)		CHROM	6 cm	Završna desna metalna noga 5101D dimenzije 6x61x100h cm lakirana u boju kroma	1 x 5101 D	6
			61 cm	Final right metal leg 5101D dimensions 6x61x100h cm chrome varnished		0,047
			100 cm			1
5102 (REC 102/G)		CHROM	6 cm	Srednja metalna noga 5102 dimenzije 6x61x100h cm lakirana u boju kroma	1 x 5102	6
			61 cm	Middle left metal leg 5102 dimensions 6x61x100h cm chrome varnished		0,047
			100 cm			1
5111 (REC 60/PL)		G, M, CH TR, LM, WH, SB, SW TR E, CH TR E, LO, DO, TE CH, WL, CH NE, WL NE E, R Sb, R W, R Ro	125 cm	Top pulta 60° 5111 dimenzije 125x78x2,5h cm - konveksni drveni top debljine 25 mm	1 x 5111	17
			78 cm	Reception top 60° 5111 dimensions 125x78x2,5h cm - convex wooden top 25 mm thick		0,042
			2,5 cm			1
5112 (REC 60/AL)		G, M, CH TR, LM, WH, SB, SW TR E, CH TR E, LO, DO, TE CH, WL, CH NE, WL NE E, R Sb, R W, R Ro	145 cm	Top povišenog dijela pulta 60° 5112 dimenzije 145x50x2,5h cm - konveksni drveni top debljine 25 mm	1 x 5112	10,5
			50 cm	Raised reception top section 60° 5112 dimensions 145x50x2,5h cm - convex wooden top 25 mm thick		0,032
			2,5 cm			1
5121 (REC 60/AV)		SATINIRANO STAKLO	143 cm	Top povišenog dijela pulta 60° 5121 dimenzije 143x50x1,2h cm - konveksni satinirani stakleni top debljine 12 mm	1 x 5121	20
			50 cm	Raised reception top section 60° 5121 dimensions 143x50x1,2h cm - convex satinated glass top 12 mm thick		0,063
			1,2 cm			1
5103 (REC 60/FM)		CHROM	135 cm	Prednji konveksni metalni panel 5103 dimenzije 135x0,2x100h cm lakiran u boju kroma	1 x 5103	16,5
			0,2 cm	Frontal convex metal panel 5103 dimensions 135x0,2x100h cm chrome varnished		0,32
			100 cm			1
5113 (REC 61/PL)		G, M, CH TR, LM, WH, SB, SW TR E, CH TR E, LO, DO, TE CH, WL, CH NE, WL NE E, R Sb, R W, R Ro	130 cm	Top pulta 60° 5113 dimenzije 130x77x2,5h cm - konkavni drveni top debljine 25 mm	1 x 5113	16
			77 cm	Reception top 60° 5113 dimensions 130x77x2,5h cm - concave wooden top 25 mm thick		0,043
			2,5 cm			1
5114 (REC 61/AL)		G, M, CH TR, LM, WH, SB, SW TR E, CH TR E, LO, DO, TE CH, WL, CH NE, WL NE E, R Sb, R W, R Ro	82 cm	Top povišenog dijela pulta 60° 5114 dimenzije 82x42x2,5h cm - konkavni drveni top debljine 25 mm	1 x 5114	5,5
			42 cm	Raised reception top section 60° 5114 dimensions 82x42x2,5h cm - concave wooden top 25 mm thick		0,016
			2,5 cm			1

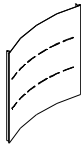
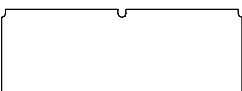
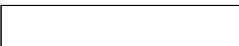
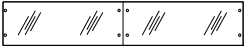
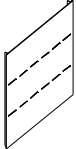

Program PULTOVI (drvene i metalne konstrukcije) / RECEPTIONS (melamine and metal construction)

ZAJEDNIČKA OZNAKA	SLIKA	IZBOR BOJA	DIM.(cm) š d v	OPIS	SASTAV	PAK. kg m3 paketa	
ARTICLE CODE	PICTURE	COLOUR SELECTION	DIM.(cm) w d h	DESCRIPTION	ASSEMBLY	PACK. kg m3 col	
5104 (REC 61/FM)		CHROM	60 cm	Prednji konkavni metalni panel 5104 dimenzije 60x0,2x100h cm lakiran u boju kroma	1 x 5104	10	
			0,2 cm				0,085
			100 cm	<i>Frotal concave metal panel 5104 dimensions 60x0,2x100h cm chrome varnished</i>		1	
5115 (REC 45/PL)		G, M, CH TR, LM, WH, SB, SW TR E, CH TR E, LO, DO, TE CH, WL, CH NE, WL NE E, R Sb, R W, R Ro	153 cm	Top pulata 45° 5115 dimenzije 153x79x2,5h cm - konkavni drveni top debljine 25 mm	1 x 5115	20	
			79 cm	<i>Reception top 45° 5115 dimensions</i>		0,051	
			2,5 cm	<i>153x79x2,5h cm - concave wooden top 25 mm thick</i>		1	
5116 (REC 45/AL)		G, M, CH TR, LM, WH, SB, SW TR E, CH TR E, LO, DO, TE CH, WL, CH NE, WL NE E, R Sb, R W, R Ro	116 cm	Top povišenog dijela pulata 45° 5116 dimenzije 116x45x2,5h cm - konkavni drveni top debljine 25 mm	1 x 5116	8,5	
			45 cm	<i>Raised reception top section 45° 5116 dimensions 116x45x2,5h cm - concave</i>		0,023	
			2,5 cm	<i>wooden top 25 mm thick</i>		1	
5122 (REC 45/AV)		SATINIRANO STAKLO	114 cm	Top povišenog dijela pulata 45° 5122 dimenzije 114x45x1,2h cm - konkavni satinirani stakleni top debljine 12 mm	1 x 5122	16	
			45 cm	<i>Raised reception top section 45° 5122 dimensions 114x45x1,2h cm - concave</i>		0,043	
			1,2 cm	<i>satinated glass top 12 mm thick</i>		1	
5105 (REC 45/FM)		CHROM	99,5 cm	Prednji konkavni metalni panel 5105 dimenzije 99,5x0,2x100h cm lakiran u boju kroma	1 x 5105	13	
			0,2 cm				0,015
			100 cm	<i>Frotal concave metal panel 5105 dimensions 99,5x0,2x100h cm chrome varnished</i>		1	
5117 (REC 20/PL)		G, M, CH TR, LM, WH, SB, SW TR E, CH TR E, LO, DO, TE CH, WL, CH NE, WL NE E, R Sb, R W, R Ro	200 cm	Top pulata 5117 dimenzije 200x70x2,5h cm - ravni drveni top debljine 25 mm	1 x 5117	32	
			70 cm				0,06
			2,5 cm	<i>Reception top 5117 dimensions 200x70x2,5h cm - linear wooden top 25 mm thick</i>		1	
5118 (REC 20/AL)		G, M, CH TR, LM, WH, SB, SW TR E, CH TR E, LO, DO, TE CH, WL, CH NE, WL NE E, R Sb, R W, R Ro	200 cm	Top povišenog dijela pulata 5118 dimenzije 200x36x2,5h cm - ravni drveni top debljine 25 mm	1 x 5118	15,5	
			36 cm	<i>Raised reception top section 5118 dimensions</i>		0,032	
			2,5 cm	<i>200x36x2,5h cm - linear wooden top 25 mm thick</i>		1	
5123 (REC 20/AV)		SATINIRANO STAKLO	199 cm	Top povišenog dijela pulata 5123 dimenzije 199x36x1,2h cm - ravni satinirani stakleni top debljine 12 mm	1 x 5123	28	
			36 cm	<i>Raised reception top section 5123 dimensions</i>		0,068	
			1,2 cm	<i>199x36x1,2h cm - linear satinated glass top 12 mm thick</i>		2	
5106 (REC 10/FM)		CHROM	100 cm	Prednji ravni metalni panel 5106 dimenzije 100x0,2x100h cm lakiran u boju kroma	1 x 5106	12,5	
			0,2 cm				0,084
			100 cm	<i>Frotal linear metal panel 5106 dimensions 100x0,2x100h cm chrome varnished</i>		1	
5119 (REC 10/PL)		G, M, CH TR, LM, WH, SB, SW TR E, CH TR E, LO, DO, TE CH, WL, CH NE, WL NE E, R Sb, R W, R Ro	100 cm	Top pulata 5119 dimenzije 100x70x2,5h cm - ravni drveni top debljine 25 mm	1 x 5119	16	
			70 cm				0,03
			2,5 cm	<i>Reception top 5119 dimensions 100x70x2,5h cm - linear wooden top 25 mm thick</i>		1	

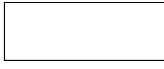
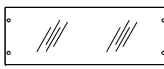
Program PULTOVI (drvene i metalne konstrukcije) / RECEPTIONS (melamine and metal construction)

ZAJEDNIČKA OZNAKA	SLIKA	IZBOR BOJA	DIM.(cm) š d v	OPIS	SASTAV	PAK. kg m3 paketa
ARTICLE CODE	PICTURE	COLOUR SELECTION	DIM.(cm) w d h	DESCRIPTION	ASSEMBLY	PACK. kg m3 col
5120 (REC 10/AL)		G, M, CH TR, LM, WH, SB, SW TR E, CH TR E, LO, DO, TE CH, WL, CH NE, WL NE E, R Sb, R W, R Ro	100 cm	Top povišenog dijela pulta 5120 dimenzije 100x36x2,5h cm - ravni drveni top debljine 25 mm	1 x 5120	8
			36 cm	<i>Raised reception top section 5120 dimensions</i>		0,016
			2,5 cm	<i>100x36x2,5h cm - linear wooden top 25 mm thick</i>		1
5124 (REC 10/AV)		SATINIRANO STAKLO	99 cm	Top povišenog dijela pulta 5124 dimenzije 99x36x1,2h cm - ravni satinirani stakleni top debljine 12 mm	1 x 5124	14
			36 cm	<i>Raised reception top section 5124 dimensions</i>		0,034
			1,2 cm	<i>99x36x1,2h cm - linear satinated glass top 12 mm thick</i>		1

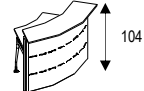
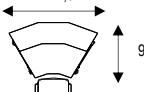
PRIMJERI SLOŽENIH KOMPOZICIJA PULTOVA METALNE KONSTRUKCIJE
EXAMPLES OF RECEPTION COMPOSITIONS - METAL CONSTRUCTION

5911		G M CH TR LM WH SB SW TR E CH TR E LO DO TE CH WL CH NE WL NE E R Sb R W R Ro	144,5 cm	Kompozicija pulta 5911 dimenzije 144,5x92,5x104h cm sa drvenim topom radne površine i drvenim/staklenim gornjim topom	1 x 5111	56	
			92,5 cm				1 x 5112
			104 cm		<i>Reception composition 5911 dimensions</i>		1 x 5103
						0,488	
				<i>144,5x92,5x104h cm with wooden desktop and wooden/glass upper top</i>	1 x 5101 D		
					1 x 5101 L		
						5	
5912		G M CH TR LM WH SB SW TR E CH TR E LO DO TE CH WL CH NE WL NE E R Sb R W R Ro	250 cm	Kompozicija pulta 5912 dimenzije 250x115x104h cm sa drvenim topom radne površine i drvenim/staklenim gornjim topom	2 x 5111	106	
			115 cm				2 x 5112
			104 cm		<i>Reception composition 5912 dimensions</i>		2 x 5103
						0,929	
				<i>250x115x104h cm with wooden desktop and wooden/glass upper top</i>	1 x 5101 L		
					1 x 5102		
					1 x 5101 D		
						9	
5913		G M CH TR LM WH SB SW TR E CH TR E LO DO TE CH WL CH NE WL NE E R Sb R W R Ro	290 cm	Kompozicija pulta 5913 dimenzije 290x145x104h cm sa drvenim topom radne površine i drvenim/staklenim gornjim topom	3 x 5111	156	
			145 cm				3 x 5112
			104 cm		<i>Reception composition 5913 dimensions</i>		3 x 5103
						1,37	
				<i>290x145x104h cm with wooden desktop and wooden/glass upper top</i>	1 x 5101 L		
					2 x 5102		
					1 x 5101 D		
						13	

Program PULTOVI (drvene i metalne konstrukcije) / RECEPTIONS (melamine and metal construction)

ZAJEDNIČKA OZNAKA	SLIKA	IZBOR BOJA	DIM.(cm) š d v	OPIS	SASTAV	PAK. kg m3 paketa			
ARTICLE CODE	PICTURE	COLOUR SELECTION	DIM.(cm) w d h	DESCRIPTION	ASSEMBLY	PACK. kg m3 col			
5914		G M CH TR LM WH SB SW TR E CH TR E LO DO TE CH WL CH NE WL NE E R Sb R W R Ro	290 cm	Kompozicija pulta 5914 dimenzije 290x217x104h cm sa drvenim topom radne površine i drvenim/staklenim gornjim topom	4 x 5111	206			
			217 cm		4 x 5112		4 x 5103	1 x 5101 L	
			104 cm	Reception composition 5914 dimensions 290x217x104h cm with wooden desktop and wooden/glass upper top	3x 5102		1 x 5101 D	1,811	
									17
5915		G M CH TR LM WH SB SW TR E CH TR E LO DO TE CH WL CH NE WL NE E R Sb R W R Ro	103,5 cm	Kompozicija pulta 5915 dimenzije 130x90x104h cm sa drvenim topom radne površine i drvenim/staklenim gornjim topom	1 x 5113	43,5			
			90 cm		1 x 5114		1 x 5104	1 x 5101 D	0,238
			104 cm	Reception composition 5915 dimensions 130x90x104h cm with wooden desktop and wooden/glass upper top				1 x 5101 L	5
5916		G M CH TR LM WH SB SW TR E CH TR E LO DO TE CH WL CH NE WL NE E R Sb R W R Ro	225 cm	Kompozicija pulta 5916 dimenzije 225x107x104h cm sa drvenim topom radne površine i drvenim/staklenim gornjim topom	2 x 5113	81			
			107 cm		2 x 5114		2 x 5104	1 x 5101 L	0,429
			104 cm	Reception composition 5916 dimensions 225x107x104h cm with wooden desktop and wooden/glass upper top	1 x 5102		1 x 5101 D	9	
5917		G M CH TR LM WH SB SW TR E CH TR E LO DO TE CH WL CH NE WL NE E R Sb R W R Ro	260 cm	Kompozicija pulta 5917 dimenzije 260x130x104h cm sa drvenim topom radne površine i drvenim/staklenim gornjim topom	3 x 5113	112,5			
			130 cm		3 x 5114		3 x 5104	1 x 5101 L	0,573
			104 cm	Reception composition 5917 dimensions 260x130x104h cm with wooden desktop and wooden/glass upper top	2 x 5102		1 x 5101 D	13	
5918		G M CH TR LM WH SB SW TR E CH TR E LO DO TE CH WL CH NE WL NE E R Sb R W R Ro	153 cm	Kompozicija pulta 5918 dimenzije 153x95x104h cm sa drvenim topom radne površine i drvenim/staklenim gornjim topom	1 x 5115	53,5			
			95 cm		1 x 5116		1 x 5105	1 x 5101 L	0,318
			104 cm	Reception composition 5918 dimensions 153x95x104h cm with wooden desktop and wooden/glass upper top				1 x 5101 D	5

Program PULTOVI (drvene i metalne konstrukcije) / RECEPTIONS (melamine and metal construction)

ZAJEDNIČKA OZNAKA	SLIKA	IZBOR BOJA	DIM.(cm) š d v	OPIS	SASTAV	PAK. kg m3 paketa							
ARTICLE CODE	PICTURE	COLOUR SELECTION	DIM.(cm) w d h	DESCRIPTION	ASSEMBLY	PACK. kg m3 col							
5919		G M CH TR LM WH SB SW TR E CH TR E LO DO TE CH WL CH NE WL NE E R Sb R W R Ro	370 cm	Kompozicija pulta 5919 dimenzije 370x156x104h cm sa drvenim topom radne površine i drvenim/staklenim gornjim topom	3 x 5115	148,5							
			156 cm		3 x 5116		3 x 5105	1 x 5101 L	2 x 5102	1 x 5101 D			
			104 cm	Reception composition 5919 dimensions 370x156x104h cm with wooden desktop and wooden/glass upper top					0,86				
										13			
5920		G M CH TR LM WH SB SW TR E CH TR E LO DO TE CH WL CH NE WL NE E R Sb R W R Ro	106 cm	Kompozicija pulta 5920 dimenzije 106x85x104h cm sa drvenim topom radne površine i drvenim/staklenim gornjim topom	1 x 5119	48,5							
			85 cm		1 x 5120		1 x 5106	1 x 5101 L	1 x 5101 D				
			104 cm	Reception composition 5920 dimensions 106x85x104h cm with wooden desktop and wooden/glass upper top					0,224				
										5			
5921		G M CH TR LM WH SB SW TR E CH TR E LO DO TE CH WL CH NE WL NE E R Sb R W R Ro	206 cm	Kompozicija pulta 5921 dimenzije 206x85x104h cm sa drvenim topom radne površine i drvenim/staklenim gornjim topom	1 x 5117	90,5							
			85 cm		1 x 5118		2 x 5106	1 x 5101 L	1 x 5102	1 x 5101 D			
			104 cm	Reception composition 5921 dimensions 206x85x104h cm with wooden desktop and wooden/glass upper top					0,401				
										7			
5922		G M CH TR LM WH SB SW TR E CH TR E LO DO TE CH WL CH NE WL NE E R Sb R W R Ro	280 cm	Kompozicija pulta 5922 dimenzije 280x115x104h cm sa drvenim topom radne površine i drvenim/staklenim gornjim topom	1 x 5117	140,5							
			115 cm		1 x 5118		2 x 5106	1 x 5111	1 x 5112	1 x 5103	1 x 5101 L	2 x 5102	1 x 5101 D
			104 cm	Reception composition 5922 dimensions 280x115x104h cm with wooden desktop and wooden/glass upper top									0,842
													11
5923		G M CH TR LM WH SB SW TR E CH TR E LO DO TE CH WL CH NE WL NE E R Sb R W R Ro	350 cm	Kompozicija pulta 5923 dimenzije 350x115x104h cm sa drvenim topom radne površine i drvenim/staklenim gornjim topom	2 x 5111	132							
			115 cm		2 x 5112		2 x 5103	1 x 5119	1 x 5120	1 x 5106	1 x 5101 L	1 x 5101 D	2 x 5102
			104 cm	Reception composition 5923 dimensions 350x115x104h cm with wooden desktop and wooden/glass upper top									0,786
													13



Program PULTOVI (drvene i metalne konstrukcije) / RECEPTIONS (melamine and metal construction)

ZAJEDNIČKA OZNAKA	SLIKA	IZBOR BOJA	DIM.(cm) š d v	OPIS	SASTAV	PAK. kg m3 paketa
ARTICLE CODE	PICTURE	COLOUR SELECTION	DIM.(cm) w d h	DESCRIPTION	ASSEMBLY	PACK. kg m3 col
5924		G M CH TR LM WH SB SW TR E CH TR E LO DO TE CH WL CH NE WL NE E R Sb R W R Ro	312 cm	Kompozicija pulta 5924 dimenzije 312x130x104h cm sa drvenim topom radne površine i drvenim/staklenim gornjim topom <i>Reception composition 5924 dimensions 312x130x104h cm with wooden desktop and wooden/glass upper top</i>	2 x 5113	128,5
			130 cm		2 x 5114	
					2 x 5104	
			104 cm		1 x 5115	
1 x 5116						
5925		G M CH TR LM WH SB SW TR E CH TR E LO DO TE CH WL CH NE WL NE E R Sb R W R Ro	390 cm	Kompozicija pulta 5925 dimenzije 390x217x104h cm sa drvenim topom radne površine i drvenim/staklenim gornjim topom <i>Reception composition 5925 dimensions 390x217x104h cm with wooden desktop and wooden/glass upper top</i>	4 x 5111	248,5
			217 cm		4 x 5112	
					4 x 5103	
			104 cm		1 x 5119	
1 x 5120						
5926		G M CH TR LM WH SB SW TR E CH TR E LO DO TE CH WL CH NE WL NE E R Sb R W R Ro	335 cm	Kompozicija pulta 5926 dimenzije 335x110x104h cm sa drvenim topom radne površine i drvenim/staklenim gornjim topom <i>Reception composition 5926 dimensions 335x110x104h cm with wooden desktop and wooden/glass upper top</i>	2 x 5111	143,5
			110 cm		2 x 5112	
					2 x 5103	
			104 cm		1 x 5113	
1 x 5114						
5927		G M CH TR LM WH SB SW TR E CH TR E LO DO TE CH WL CH NE WL NE E R Sb R W R Ro	320 cm	Kompozicija pulta 5927 dimenzije 320x110x104h cm sa drvenim topom radne površine i drvenim/staklenim gornjim topom <i>Reception composition 5927 dimensions 320x110x104h cm with wooden desktop and wooden/glass upper top</i>	1 x 5117	128
			110 cm		1 x 5118	
					2 x 5106	
			104 cm		1 x 5113	
1 x 5114						
5928		G M CH TR LM WH SB SW TR E CH TR E LO DO TE CH WL CH NE WL NE E R Sb R W R Ro	425 cm	Kompozicija pulta 5928 dimenzije 425x194x104h cm sa drvenim topom radne površine i drvenim/staklenim gornjim topom <i>Reception composition 5928 dimensions 425x194x104h cm with wooden desktop and wooden/glass upper top</i>	3 x 5119	208,5
			194 cm		3 x 5120	
					3 x 5106	
			104 cm		2 x 5113	
2 x 5114						
5928		G M CH TR LM WH SB SW TR E CH TR E LO DO TE CH WL CH NE WL NE E R Sb R W R Ro	194 cm	Kompozicija pulta 5928 dimenzije 425x194x104h cm sa drvenim topom radne površine i drvenim/staklenim gornjim topom <i>Reception composition 5928 dimensions 425x194x104h cm with wooden desktop and wooden/glass upper top</i>	2 x 5104	0,96
			104 cm		1 x 5101 L	
					1 x 5101 D	
			104 cm		4 x 5102	

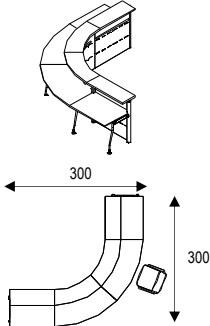
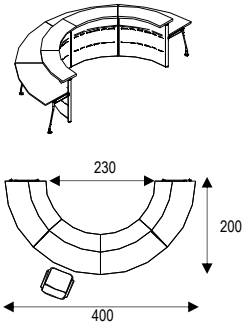
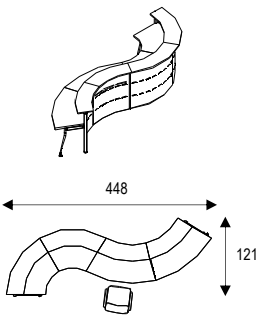
Program PULTOVI (drvene i metalne konstrukcije) / RECEPTIONS (melamine and metal construction)

ZAJEDNIČKA OZNAKA	SLIKA	IZBOR BOJA	DIM.(cm) š d v	OPIS	SASTAV	PAK. kg m3 paketa
ARTICLE CODE	PICTURE	COLOUR SELECTION	DIM.(cm) w d h	DESCRIPTION	ASSEMBLY	PACK. kg m3 col
5929		G M CH TR LM WH SB SW TR E CH TR E LO DO TE CH WL CH NE WL NE E R Sb R W R Ro	300 cm	Kompozicija pulta 5929 dimenzije 300x300x104h cm sa drvenim topom radne površine i drvenim/staklenim gornjim topom	2 x 5115	186
			300 cm		2 x 5116	
					2 x 5105	
			104 cm		2 x 5119	
					2 x 5120	
			Reception composition 5929 dimensions 300x300x104h cm with wooden desktop and wooden/glass upper top		2 x 5106	
1 x 5101 L						
1 x 5101 D						
5930		G M CH TR LM WH SB SW TR E CH TR E LO DO TE CH WL CH NE WL NE E R Sb R W R Ro	400 cm	Kompozicija pulta 5930 dimenzije 400x200x104h cm sa drvenim topom radne površine i drvenim/staklenim gornjim topom	4 x 5115	196
			200 cm		4 x 5116	
					4 x 5105	
			104 cm		1 x 5101 L	
					1 x 5101 D	
			Reception composition 5930 dimensions 400x200x104h cm with wooden desktop and wooden/glass upper top		3 x 5102	
5931		G M CH TR LM WH SB SW TR E CH TR E LO DO TE CH WL CH NE WL NE E R Sb R W R Ro	448 cm	Kompozicija pulta 5931 dimenzije 448x121x104h cm sa drvenim topom radne površine i drvenim/staklenim gornjim topom	2 x 5115	201
			121 cm		2 x 5116	
					2 x 5105	
			104 cm		2 x 5111	
					2 x 5112	
			Reception composition 5931 dimensions 448x121x104h cm with wooden desktop and wooden/glass upper top		2 x 5103	
1 x 5101 L						
1 x 5101 D						

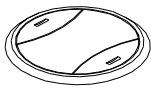
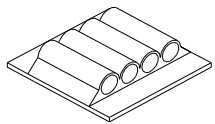
DODACI PULTEVIMA
RECEPTION ACCESSORIES

3094		CRNA SIVA BIJELA	6 cm	Držač za kablove 3094 dimenzije 6x6x0,5h cm, za sve radne i konferencijske stolove. Dostupna u crnoj, sivoj i bijeloj boji Cable holder 3094 dimensions 6x6x0,5h cm, for all work and conference tables. Available in black, grey and white colour.	1 x 3094	0,004
			6 cm			
			0.5 cm			
3095		CRNA SIVA BIJELA	8 cm	Držač za kablove 3095 dimenzije 8x4x2h cm, za sve radne i konferencijske stolove. Dostupna u crnoj, sivoj i bijeloj boji Cable holder 3095 dimensions 8x4x2h cm, for all work and conference tables. Available in black colour.	1 x 3095	0,005
			4 cm			
			2 cm			
3096		RAL 9006	6 cm	Držač za kablove 3096 dimenzije 6x6x66-77h cm, za sve radne i konferencijske stolove s metalnim nogama. Cable holder 3096 dimensions 6x6x66-77h cm, for all work and conference tables with metal legs.	1 x 3096	1
			6 cm			
			66-77 cm			

TEHNIČKI OPIS

TECHNICAL DESCRIPTION

PULTOVI DRVENE KONSTRUKCIJE RECEPTION - WOODEN CONSTRUCTION

Svi dijelovi pulta osim metalnog potpornog stupića su od kvalitetnog materijala presvučenog melaminskom folijom. Završne ploče i noge pulta su debljine 25 mm, dok su prednje ploče i vrata debljine 18 mm. Rubovi su kantirani rubnom trakom debljine 2 mm zaobljenih rubova sa radijusom $r=2$ mm. Metalni potporni stupići su lakirani u crnoj boji. Linearni elementi dužine od 85 do 160 cm mogu se kombinirati sa unutarnjim i vanjskim kutnim dijelom pulta čime se mogu složiti brojne konfiguracije pulteva.

All parts of the reception, except the metal supporting columns, are made of high quality chipboard melamine. Tops and legs are 25 mm thick, while the front panel and door are 18 mm thick. The edges are covered with 2 mm thick ABS with rounded edges ($r=2$ mm). Metal supporting columns are painted in black. The linear elements of length 85-160 cm can be combined with internal and external angular part of the reception which can be combined in many configurations of receptions.

PULTOVI METALNE KONSTRUKCIJE RECEPTION - METAL CONSTRUCTION

Završne ploče tj. topovi stolova i dodataka izrađeni su od kvalitetnog materijala presvučenog melaminskom folijom debljine 25 ili 30mm. Rubovi su kantirani ABS rubnom trakom debljine 2 mm zaobljenih rubova sa radijusom $r=2$ mm. Gornje ploče je osim iverala moguće izvesti i u satiniranom staklu debljine 12 mm. Metalne noge i prednja fronta su lakirani u sivoj boji. Linearni elementi dužine 100 i 200 cm mogu se kombinirati sa konveksnim i konkavnim kutnim elementima od 45° i 60° . Na ovaj način se mogu složiti brojne kompozicije recepcija.

Tops and ends are made of chipboard melamine panels 25 mm thick. The edges are covered with ABS edge tape 2 mm thick with rounded edges ($r=2$ mm). The upper reception top is possible to make from satinated glass 12 mm thick. Metal legs and fronts are painted in gray. The linear elements of length 100 and 200 cm can be combined with convex and concave corners of 45° and 60° degrees. In this way we can form a number of reception compositions.

NAPOMENA U VEZI IZBORA BOJA REMARK ABOUT COLOURS

Navedene boje u našoj ponudi su uvijek identične u svakoj isporuci. Međutim, naziv (trešnja, javor i sl.) niti približno ne definira boju iverala. Na tržištu se mogu pojaviti stotine različitih varijacija pod oznakom npr. trešnja, a što je posljedica uzgoja ovog drveta u vrlo različitim klimatskim uvjetima. Isto tako i boje siva, antracit i sl. mogu se pojaviti u puno različitih nijansi. Zbog navedenog razloga na našim dostavnim dokumentima navodimo klauzulu: "Reklamaciju na vaš odabir boja nakon isporuke ne prihvaćamo".

Available colours in our assortment are identical in every delivery. However the name (cherry, maple etc.) does not indicate the exact design. There are hundreds of different variations under the name for example cherry, which is caused by growing of cherry tree in different climate conditions. Uni colours like gray, anthracite etc. can also be in different designs. Due to above stated there is a remark on our delivery documentation: "After delivery, complaint on your selection of colours will not be accepted"