

# TEMPUS ECONOMY metalne noge

*TEMPUS ECONOMY metal legs*

(Topovi stolova debljine 36mm / *desktop 36mm thick*)



## BOJE - COLOURS

TE CH

trešnja  
*cherry*  
SCH 8R6



**TEMPUS ECONOMY metalne noge / TEMPUS ECONOMY metal legs**

ZAJEDNIČKA OZNAKA	SLIKA	IZBOR BOJA	DIM.(cm) š d v	OPIS	SASTAV	PAK. kg m3 paketa
ARTICLE CODE	PICTURE	COLOUR SELECTION	DIM.(cm) w d h	DESCRIPTION	ASSEMBLY	PACK. kg m3 col

**PRAVOKUTNI RADNI STOLOVI ŠIRINE 80 cm (DEBLJINA TOPOVA 36mm)**  
**RECTANGULAR WORK TABLES WIDTH 80 cm (DESKTOP 36mm THICK)**

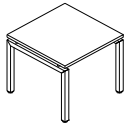
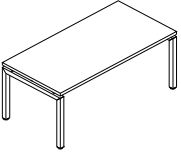
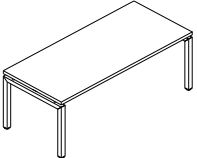
7101 E		TE CH	80 cm	Pravokutni radni stol 7101 E dimenzije 80x80x73,1h cm s sivim metalnim nogama profila 50x50 mm	1 x 7101 E	27
			80 cm	<i>Rectangular work table 7101 E dimensions 80x80x73,1h cm with grey metal legs profile 50x50 mm</i>		0,1155
			73,1 cm			4
7102 E		TE CH	160 cm	Pravokutni radni stol 7102 E dimenzije 160x80x73,1h cm s sivim metalnim nogama profila 50x50 mm	1 x 7102 E	41
			80 cm	<i>Rectangular work table 7102 E dimensions 160x80x73,1h cm with grey metal legs profile 50x50 mm</i>		0,161
			73,1 cm			4
7103 E		TE CH	180 cm	Pravokutni radni stol 7103 E dimenzije 180x80x73,1h cm s sivim metalnim nogama profila 50x50 mm	1 x 7103 E	46
			80 cm	<i>Rectangular work table 7103 E dimensions 180x80x73,1h cm with grey metal legs profile 50x50 mm</i>		0,1723
			73,1 cm			4

**PRAVOKUTNI RADNI STOLOVI ŠIRINE 90 cm (DEBLJINA TOPOVA 36mm)**  
**RECTANGULAR WORK TABLES WIDTH 90 cm (DESKTOP 36mm THICK)**

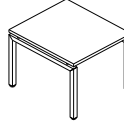
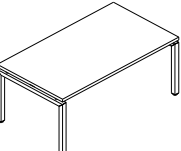
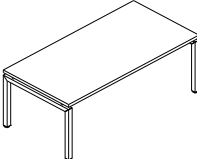
7111 E		TE CH	80 cm	Pravokutni radni stol 7111 E dimenzije s 80x90x73,1h cm sivim metalnim nogama profila 50x50 mm	1 x 7111 E	28
			90 cm	<i>Rectangular work table 7111 E dimensions 80x90x73,1h cm with grey metal legs profile 50x50 mm</i>		0,126
			73,1 cm			4
7112 E		TE CH	180 cm	Pravokutni radni stol 7112 E dimenzije 180x90x73,1h cm s sivim metalnim nogama profila 50x50 mm	1 x 7112 E	42
			90 cm	<i>Rectangular work table 7112 E dimensions 180x90x73,1h cm with grey metal legs profile 50x50 mm</i>		0,1715
			73,1 cm			4
7113 E		TE CH	200 cm	Pravokutni radni stol 7113 E dimenzije 200x90x73,1h cm s sivim metalnim nogama profila 50x50 mm	1 x 7113 E	47
			90 cm	<i>Rectangular work table 7113 E dimensions 200x90x73,1h cm with grey metal legs profile 50x50 mm</i>		0,1828
			73,1 cm			4

**DODACI RADNIM STOLOVIMA ŠIRINE 80 cm (DEBLJINA TOPOVA 36mm)**  
**WORK TABLE ENDS FOR TABLES WIDTH 80 cm (DESKTOP 36mm THICK)**

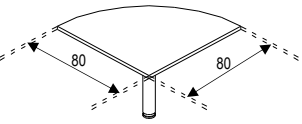
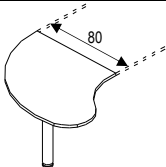
7041 E		TE CH	80 cm	Kutni dodatak 90° 7041 E dimenzije 80x80x73,1h cm sa okruglom sivom metalnom nogom za radni stol	1 x 7041 E	15
			80 cm	<i>Angle 90° 7041 E dimensions 80x80x73,1h cm with round grey metal leg for work table</i>		0,0564
			73,1 cm			2
7042L E 7042D E		TE CH	80 cm	Kontakt nastavak 7042 E dimenzije 80x111x73,1h cm sa okrug. sivom met. nogom za radni stol (lijevi ili desni)	1 x 7042(L/D) E	18
			111 cm	<i>Tear-drop end 7042 E dimensions 80x111x73,1h cm with round grey metal leg for work table (left or right)</i>		0,0795
			73,1 cm			2

**TEMPUS ECONOMY metalne noge / TEMPUS ECONOMY metal legs**

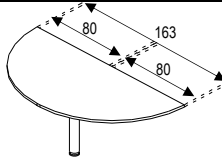
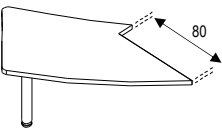
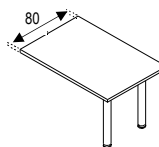
ZAJEDNIČKA OZNAKA	SLIKA	IZBOR BOJA	DIM.(cm) š d v	OPIS	SASTAV	PAK. kg m3 paketa	
ARTICLE CODE	PICTURE	COLOUR SELECTION	DIM.(cm) w d h	DESCRIPTION	ASSEMBLY	PACK. kg m3 col	
7045 E		TE CH	80 cm	Dodatak 7045 E dimenzije 80x163x73,1h cm sa okruglom sivom metalnom nogom za dva radna stola	1 x 7045 E	25	
			163 cm				Shaped end 7045 E dimensions 80x163x73,1h cm with round grey metal leg for two work tables
			73,1 cm				
7046L E 7046D E		TE CH	180 cm	Dodatak 7046 E dimenzije 180x75x73,1h cm sa 1 okruglom sivom metalnom nogom za radni stol	1 x 7046 E	25	
			75 cm				Shaped end 7046 E dimensions 180x75x73,1h cm with 1 round grey metal leg for work table
			73,1 cm				
7047 E		TE CH	80 cm	Dodatak 7047 E dimenzije 80x120x73,1h cm sa 2 okrugle sive metalne noge za radni stol	1 x 7047 E	24	
			120 cm				Shaped end 7047 E dimensions 80x120x73,1h cm with 2 round grey metal legs for work table
			73,1 cm				

**DODACI RADNIM STOLOVIMA ŠIRINE 90 cm (DEBLJINA TOPOVA 36mm)  
WORK TABLE ENDS FOR TABLES WIDTH 90 cm (DESKTOP 36mm THICK)**

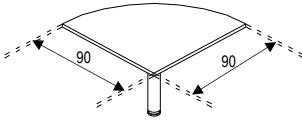
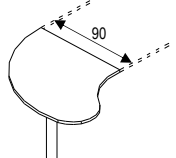
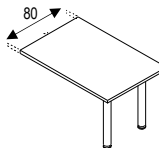
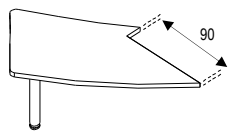
7043 E		TE CH	90 cm	Kutni dodatak 90° 7043 E dimenzije 90x90x73,1h cm sa okruglom sivom metalnom nogom za radni stol	1 x 7043 E	19	
			90 cm				Angle 90° 7043 E dimensions 90x90x73,1h cm with round grey metal leg for work table
			73,1 cm				
7044L E 7044D E		TE CH	90 cm	Kontakt nastavak 7044 E dimenzije 90x125x73,1h cm sa okrug. sivom met. nogom za radni stol (lijevi ili desni)	1 x 7044(L/D) E	22	
			125 cm				Tear-drop end 7044 E dimensions 90x125x73,1h cm with round grey metal leg for work table (left or right)
			73,1 cm				
7047 E		TE CH	80 cm	Dodatak 7047 E dimenzije 80x120x73,1h cm sa 2 okrugle sive metalne noge za radni stol	1 x 7047 E	24	
			120 cm				Shaped end 7047 E dimensions 80x120x73,1h cm with 2 round grey metal legs for work table
			73,1 cm				
7048L E 7048D E		TE CH	190 cm	Dodatak 7048 E dimenzije 190x75x73,1h cm sa 1 okruglom sivom metalnom nogom za radni stol	1 x 7048 E	26	
			75 cm				Shaped end 7048 E dimensions 190x75x73,1h cm with 1 round grey metal leg for work table
			73,1 cm				

**KOMPAKT RADNI STOLOVI ŠIRINE 80 cm (DEBLJINA TOPOVA 36mm)  
COMPACT WORK TABLES WIDTH 80 cm (DESKTOP 36mm THICK)**

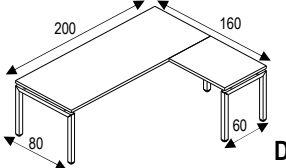
7104 E		TE CH	200 cm	Kompakt radni stol 7104 E dimenzije 200x160x73,1h cm širine 80 cm s sivim metalnim nogama profila 50x50 mm (lijevi ili desni)	1 x 7104(L/D) E	73	
			160 cm				Compact work table 7104 E dimensions 200x160x73,1h cm width 80 cm with grey metal legs profile 50x50 mm (left or right)
			73,1 cm				



**TEMPUS ECONOMY metalne noge / TEMPUS ECONOMY metal legs**

ZAJEDNIČKA OZNAKA	SLIKA	IZBOR BOJA	DIM.(cm) š d v	OPIS	SASTAV	PAK. kg m3 paketa
ARTICLE CODE	PICTURE	COLOUR SELECTION	DIM.(cm) w d h	DESCRIPTION	ASSEMBLY	PACK. kg m3 col

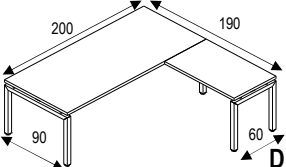
**KOMPAKT RADNI STOLOVI ŠIRINE 90 cm (DEBLJINA TOPOVA 36mm)**
**COMPACT WORK TABLES WIDTH 90 cm (DESKTOP 36mm THICK)**

7114 E		TE CH	200 cm	Kompakt radni stol 7114 E dimenzije 200x190x73,1h cm širine 90 cm s sivim metalnim nogama profila 50x50 mm (lijevi ili desni)	1 x 7114(LD) E	80
			190 cm	<i>Compact work table 7114 E dimensions</i>		0,2763
			73,1 cm	<i>200x190x73,1h cm width 90 cm with grey metal legs profile 50x50 mm (left or right)</i>		7

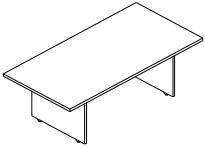
**KONFERENCIJSKI STOLOVI I KLUB STOLIĆI**
**CONFERENCE TABLES AND TABLES FOR WAITING ROOM**

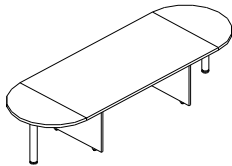
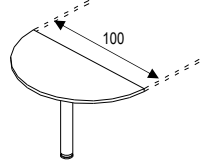
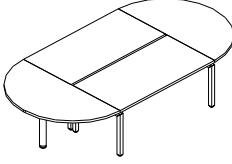
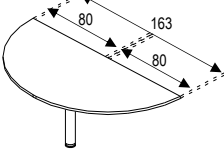
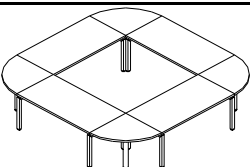
7071 E		TE CH	200 cm	Konferencijski stol 7071 E dimenzije 200x100x73,1h cm s drvenim nogama - top 36mm	1 x 7071 E	61
			100 cm	<i>Conference table 7071 E dimensions</i>		0,2083
			73,1 cm	<i>200x100x73,1h cm with wooden legs - top 36mm</i>		2
7072 E		TE CH	110 cm	Okrugli konferencijski stol 7072 E dimenzije Ø110x73,1h cm s drvenim nogama - top 36mm	1 x 7072 E	32
			110 cm	<i>Round conference table 7072 E dimensions</i>		0,117
			73,1 cm	<i>Ø110x73,1h cm with wooden legs - top 36mm</i>		1
7940 E		TE CH	300 cm	Kompozicija konferencijskog stola 7940 E dimenzije 300x100x73,1h cm - top 36mm	1 x 7071 E 2 x 7081 E	98
			100 cm	<i>Composition of conference table 7940 E</i>		0,2776
			73,1 cm	<i>dimensions 300x100x73,1h cm - top 36mm</i>		6
7081 E		TE CH	50 cm	Dodatak 7081 E dimenzije 50x100x73,1h cm sa okruglom sivom metalnom nogom za konferencijski stol - top 36mm	1 x 7081 E	21
			100 cm	<i>Round end 7081 E dimensions 50x100x73,1h cm with round grey metal leg for conference table - top 36mm</i>		0,0693
			73,1 cm			2
7970 E		TE CH	320 cm	Kompozicija konferencijskog stola 7970 E dimenzije 320x163x73,1h cm - top 36mm	2 x 7102 E 2 x 7045 E	132
			163 cm	<i>Composition of conference table 7970 E</i>		0,5116
			73,1 cm	<i>dimensions 320x163x73,1h cm - top 36mm</i>		12
7045 E		TE CH	80 cm	Dodatak 7045 E dimenzije 80x163x73,1h cm sa okruglom sivom metalnom nogom za dva radna stola	1 x 7045 E	25
			163 cm	<i>Shaped end 7045 E dimensions 80x163x73,1h cm with round grey metal leg for two work tables</i>		0,0948
			73,1 cm			2
7971 E		TE CH	320 cm	Kompozicija konferencijskog stola 7971 E dimenzije 320x320x73,1h cm - top 36mm	4 x 7102 E 4 x 7041 E	224
			320 cm	<i>Composition of conference table 7971 E</i>		0,8696
			73,1 cm	<i>dimensions 320x320x73,1h cm - top 36mm</i>		24

**TEMPUS ECONOMY metalne noge / TEMPUS ECONOMY metal legs**

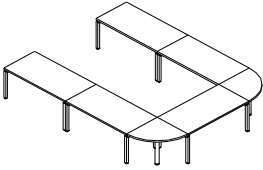
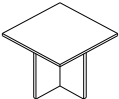
ZAJEDNIČKA OZNAKA	SLIKA	IZBOR BOJA	DIM.(cm) š d v	OPIS	SASTAV	PAK. kg m3 paketa
ARTICLE CODE	PICTURE	COLOUR SELECTION	DIM.(cm) w d h	DESCRIPTION	ASSEMBLY	PACK. kg m3 col
7972 E		TE CH	400 cm	Kompozicija konferencijskog stola 7972 E dimenzije 400x300x73,1h cm - top 36mm	5 x 7102 E 2 x 7041 E	235
			320 cm	Composition of conference table 7972 E dimensions 400x300x73,1h cm - top 36mm		0,9178
			73,1 cm			24
7073 E		TE CH	60 cm	Kvadratni klub stolić 7073 E dimenzije 60x60x50h cm s drvenim nogama - top 25mm	1 x 7073 E	15
			60 cm	Square table for waiting room 7073 E		0,0333
			50 cm	dimensions 60x60x50h cm with wooden legs - top 25mm		1

**PREDNJE PLOČE ZA RADNE STOLOVE**  
**FRONTAL PANELS FOR WORK TABLES**

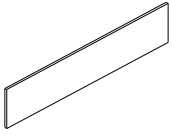
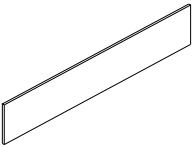
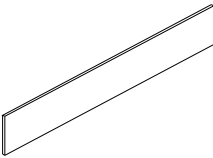
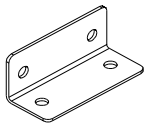
7191 E		TE CH	142 cm	Prednja ploča 7191 E dimenzije 142x1,8x32h cm za radni stol 7102 E (bez nosača)	1 x 7191 E	6
			1,8 cm	Frontal panel 7191 E dimensions 142x1,8x32h cm for work table 7102 E (without holders)		0,012
			32 cm			1
7192 E		TE CH	162 cm	Prednja ploča 7192 E dimenzije 162x1,8x32h cm za radne stolove 7103 E i 7112 E (bez nosača)	1 x 7192 E	7
			1,8 cm	Frontal panel 7192 E dimensions 162x1,8x32h cm for work tables 7103 E and 7112 E (without holders)		0,0136
			32 cm			1
7193 E		TE CH	182 cm	Prednja ploča 7193 E dimenzije 182x1,8x32h cm za radne stolove 7113 E, 7104 E i 7114 E (bez nosača)	1 x 7193 E	8
			1,8 cm	Frontal panel 7193 E dimensions 182x1,8x32h cm for work tables 7113 E, 7104 E and 7114 E (without holders)		0,0152
			32 cm			1
3198		RAL 9006	8 cm	Nosač 3198 dimenzije 8x3,5x3,5h cm za pregradu, sivi.	1 x 3198	0,05
			3,5 cm	NAPOMENA: kod dužina preko 140cm i više 3 kom potrebna		
			3,5 cm	Support 3198 dimensions 8x3,5x3,5h cm for partition panel, grey REMARK: for length over 140cm and more 3 pcs needed		1

**LADIČARI**  
**CHEST OF DRAWERS**

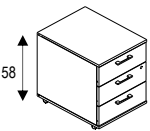
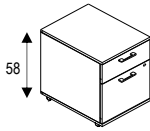
7501 E		TE CH	43 cm	Pokretna kazeta 7501 E dimenzije 43x55x58h cm s 3 drvene ladicice i dodatnom ladicom za pisači pribor dimenzije 43x55x58h cm	1 x 7501 E	20
			55 cm	Chest of drawers 7501 E dimensions		0,1521
			58 cm	43x55x58h cm with 3 wooden drawers and additional pen tray		1
7502 E		TE CH	43 cm	Pokretna kazeta za viseće mape 7502 E dimenzije 43x55x58h cm s 1 drvenom ladicom + dodatnom ladicom za pisači pribor i 1 ladicom za viseće mape	1 x 7502 E	20
			55 cm	Filing chest of drawers 7502 E dimensions		0,1521
			58 cm	43x55x58h cm with 1 wooden drawer + additional pen tray and 1 filing drawer		1

**TEMPUS ECONOMY metalne noge / TEMPUS ECONOMY metal legs**

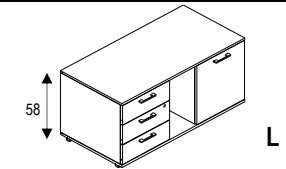
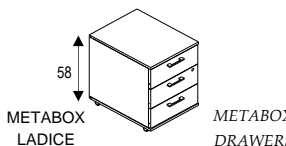
ZAJEDNIČKA OZNAKA	SLIKA	IZBOR BOJA	DIM.(cm) š d v	OPIS	SASTAV	PAK. kg m3 paketa
ARTICLE CODE	PICTURE	COLOUR SELECTION	DIM.(cm) w d h	DESCRIPTION	ASSEMBLY	PACK. kg m3 col
7503L E 7503D E		TE CH	110 cm	Mobilni element 7503 E dimenzije 110x57x58h cm s 3 drvene ladice, ladicom za pisači pribor i drv. vratima (lijevi ili desni), ladice s lijeve ili desne strane	1 x 7503(L/D) E	42
			57 cm	Side table on castors 7503 E dimensions 110x57x58h cm with 3 wooden drawers, additional pen tray and wooden doors (left or right), drawers on left or right side		0,3636
			58 cm			1
7504 E		TE CH	43 cm	Pokretna kazeta 7504 E dimenzije 43x55x58h cm s 3 metabox ladice i dodatnom ladicom za pisači pribor	1 x 7504 E	21
			55 cm	Chest of drawers 7504 E dimensions		0,1521
			58 cm	43x55x58h cm with 3 metabox drawers and additional pen tray		1

**PRIMJERI SLOŽENIH KOMPOZICIJA GDJE JE GLAVNI RADNI STOL DUŽINE 180 cm i širine 80 ili 90cm.**

(u slučaju potrebe izmjeniti u specifikaciji šifru glavnog stola, moguće dužine 160 cm za širinu 80 cm ili 200 cm za širinu 90cm)\*

*EXAMPLES OF COMPOSITIONS WITH THE MAIN DESK IN LENGTH 180 cm and depth 80 cm or 90 cm. (in case of different dimensions please change the code of main desk in the specification of composition, another available lengths are 160 cm for depth 80cm or 200 cm for depth 90cm)\**

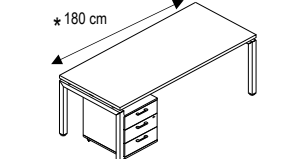
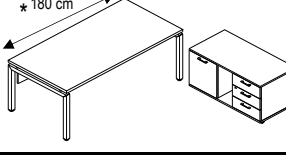
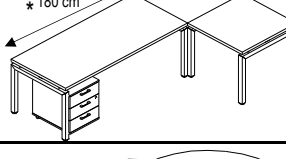
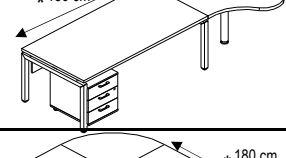
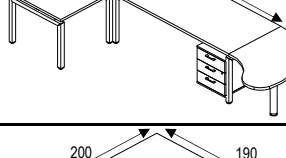
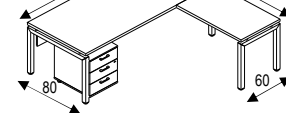
7960 E		TE CH	180 cm	Kompozicija 7960 E dimenzije 180x80x73,1h cm za 1 radno mjesto	1 x 7103 E*	66
			80 cm		1 x 7501 E	
			73,1 cm	Composition 7960 E dimensions 180x80x73,1h cm for 1 workplace		0,3244
7961 E		TE CH	180 cm	Kompozicija 7961 E dimenzije 180x200x73,1h cm za 1 radno mjesto	1 x 7112 E*	91
			200 cm		1 x 7192 E	
			73,1 cm	Composition 7961 E dimensions 180x200x73,1h cm for 1 workplace	2 x 3198 E 1 x 7503D E	0,5487
7962 E		TE CH	260 cm	Kompozicija 7962 E dimenzije 260x160x73,1h cm za 1 radno mjesto	1 x 7103 E*	108
			160 cm		1 x 7101 E	
			73,1 cm	Composition 7962 E dimensions 260x160x73,1h cm for 1 workplace	1 x 7041 E 1 x 7501 E	0,4963
7963 E		TE CH	270 cm	Kompozicija 7963 E dimenzije 270x90x73,1h cm za 1 radno mjesto	1 x 7112 E*	91
			90 cm		1 x 7044D E	
			73,1 cm	Composition 7963 E dimensions 270x90x73,1h cm for 1 workplace	1 x 7192 E 2 x 3198 E 1 x 7501 E	0,4295
7964 E		TE CH	340 cm	Kompozicija 7964 E dimenzije 340x160x73,1h cm za 1 radno mjesto	1 x 7103 E*	126
			160 cm		1 x 7101 E	
			73,1 cm	Composition 7964 E dimensions 340x160x73,1h cm for 1 workplace	1 x 7041 E 1 x 7042D E 1 x 7501 E	0,5758
7965 E		TE CH	200 cm	Kompozicija 7965 E dimenzije 200x190x73,1h cm za 1 radno mjesto	1 x 7114D E	101
			190 cm		1 x 7193 E	
			73,1 cm	Composition 7965 E dimensions 200x190x73,1h cm for 1 workplace	3 x 3198 E 1 x 7501 E	0,4436

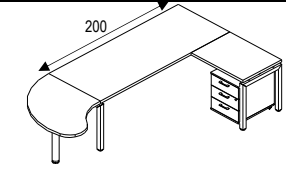
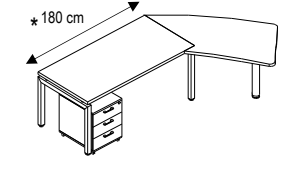
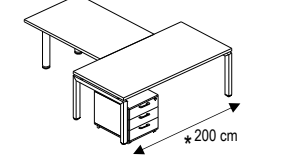

**TEMPUS ECONOMY metalne noge / TEMPUS ECONOMY metal legs**

ZAJEDNIČKA OZNAKA	SLIKA	IZBOR BOJA	DIM.(cm) š d v	OPIS	SASTAV	PAK. kg m3 paketa
ARTICLE CODE	PICTURE	COLOUR SELECTION	DIM.(cm) w d h	DESCRIPTION	ASSEMBLY	PACK. kg m3 col
7966 E		TE CH	280 cm	Kompozicija 7966 E dimenzije 290x160x73,1h cm za 1 radno mjesto	1 x 7104D E	111
			160 cm		1 x 7042L E	
			73,1 cm		1 x 7501 E	
			Composition 7966 E dimensions 290x160x73,1h cm for 1 workplace			
7935 E		TE CH	230 cm	Kompozicija 7935 E dimenzije 230x180x73,1h cm za 1 radno mjesto	1 x 7103 E*	91
			180 cm		1 x 7046D E	
			73,1 cm		1 x 7501 E	
			Composition 7935 E dimensions 230x180x73,1h cm for 1 workplace			
7936 E		TE CH	200 cm	Kompozicija 7936 E dimenzije 200x210x73,1h cm za 1 radno mjesto	1 x 7113 E*	91
			210 cm		1 x 7047 E	
			73,1 cm		1 x 7501 E	
			Composition 7936 E dimensions 200x210x73,1h cm for 1 workplace			

**NAPOMENA: SVAKA OD NAVEDENIH KOMPOZICIJA MOŽE SE NUDITI U RAZLIČITIM VELIČINAMA RADNIH STOLOVA. TAKOĐER MOGUĆE JE PROŠIRITI ILI SMANJITI PREDLOŽENE KOMPOZICIJE S TIME DA OBRATITE POZORNOST NA RASPOLOŽIVI PROSTOR.**

**REMARK: EACH COMPOSITION IS AVAILABLE IN DIFFERENT DIMENSIONS OF WORKTABLES. IT IS ALWAYS POSSIBLE TO EXPAND OR REDUCE SUGGESTED COMPOSITIONS BUT PLEASE TAKE ATTENTION TO AVAILABLE SPACE AT YOUR SITE.**

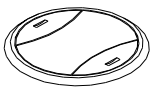
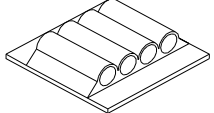
**OSTALI DODACI STOLOVIMA**
**OTHER TABLE ACCESSORIES**

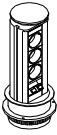
3094			6 cm	Držač za kablove 3094 dimenzije 6x6x0,5h cm, za sve radne i konferencijske stolove. Dostupna u crnoj, sivoj i bijeloj boji	1 x 3094	0,03
			6 cm		Cable holder 3094 dimensions 6x6x0,5h cm, for all work and conference tables. Available in black, grey and white colour.	
			0.5 cm			
3095			8 cm	Držač za kablove 3095 dimenzije 6x6x0,5h cm, za sve radne i konferencijske stolove. Dostupna u crnoj, sivoj i bijeloj boji	1 x 3095	0,05
			4 cm		Cable holder 3095 dimensions 6x6x0,5h cm, for all work and conference tables. Available in black, grey and white colour.	
			2 cm			
3096		RAL 9006	6 cm	Držač za kablove 3096 dimenzije 6x6x66-77h cm, za sve radne i konferencijske stolove s metalnim nogama.	1 x 3096	1
			6 cm		Cable holder 3096 dimensions 6x6x66-77h cm, for all work and conference tables with metal legs.	
			66-77 cm			
3097		RAL 9006	10 cm	Izvlačne utičnice 3097 dimenzije 10x10x38h cm, za sve radne i konferencijske stolove s metalnim nogama.	1 x 3097	1
			10 cm		Electrical socket extension 3097 dimensions 10x10x38h cm, for all work and conference tables with metal legs.	
			38 cm			

**TEHNIČKI OPIS**

**TECHNICAL DESCRIPTION**

**STOLOVI**

**TABLES**

Izrađeni su iz melaminskih panela debljine 36 mm (ploča debljine 18 mm i pojačanje ispod ploče od 18 mm), osim veznih ploča stolova koje su debljine 18 mm). Rubovi su kantirani ABS rubnom trakom debljine 2 mm zaobljenih rubova sa radiusom zaobljenja  $r = 2$  mm. Za topove radnih stolova isporučujemo sive metalne noge profila 50x50 mm.

*Tables are made of 36mm thick chipboard melamine panels (chipboard top 18mm thick with reinforcement beneath 18mm thick). Edges are covered with 2mm thick ABS tape with rounded edges ( $r=2$ mm). For work table tops we are delivering grey metal legs profile 50x50 mm.*

**DODACI STOLOVIMA**

**TABLE ENDS**

Izrađeni su iz melaminskih panela debljine 36 mm (ploča debljine 18 mm i pojačanje ispod ploče od 18 mm). Uz topove dodataka isporučujemo sive metalne noge.

*Table ends are made of melamine panels 36 mm thick (chipboard top 18mm thick with reinforcement beneath 18mm thick). For work table ends we are delivering grey round metal legs.*

**LADIČARI**

**CHEST OF DRAWERS**

Stranice, top, leđa i fronte ladica izrađeni su iz melaminskih panela debljine 18 mm, te kantirani ABS rubnom trakom. Ladice su od melaminskih panela debljine 12 mm (stranice ladica) i lakiranog MDF-a debljine 4 mm (dno ladice). Kazete su opremljene bravicom koja omogućava simultano zaključavanje svih ladica ("centralno zaključavanje"). Pokretne kazete opremljene su kotačima. Kompletna kazeta: leđa, završna ploča (top) i prednja ploča ladica (fronta) su u boji namještaja. Sve kazete dodatno su opremljene plastičnim ladicama za pisaci pribor. Posebno nudimo kazetu s metalnim metabox ladicama (7504).

*Sides, top, back and drawer fronts are made of melamine panels 18mm thick with edges covered with ABS tape. Drawers are made of melamine panels 12mm thick (sides of drawer) and lacquered MDF 4mm thick (bottom of drawer). Chest of drawers is equipped with lock that enables simultaneous locking of all drawers ("central locking"). Movable chests of drawers are equipped with wheels. Complete drawer: back, frames, fronts and tops are made in colour of the furniture. All chest of drawers are additionally equipped with pen tray. Especially we offer chest of drawers with metal metabox drawers (7504).*

**NAPOMENA U VEZI IZBORA BOJA**

**REMARK ABOUT COLOURS**

Navedene boje u našoj ponudi su uvijek identične u svakoj isporuci. Međutim naziv (trešnja, javor i sl.) niti približno ne definira boju iverala. Na tržištu se mogu pojaviti stotine različitih varijacija pod oznakom npr. trešnja, a što je posljedica uzgoja ovog drveta u vrlo različitim klimatskim uvjetima. Isto tako i boje siva, antracit i sl. mogu se pojaviti u puno različitih nijansi. Zbog navedenog razloga na našim dostavnim dokumentima navodimo klauzulu: "Reklamaciju na vaš odabir boja nakon isporuke ne prihvaćamo".

*Available colours in our assortment are identical in every delivery. However, the name (cherry, maple etc.) does not indicate the exact design. There are hundreds of different variations under the name for example cherry, which is caused by growing of cherry tree in different climate conditions. Uni colours like gray, anthracite etc. can also be in different designs. Due to above stated there is a remark on our delivery documentation: "After delivery, complaint on your selection of colours will not be accepted"*

# TEMPUS ECONOMY ormarji

*TEMPUS ECONOMY bookcases*

---



## BOJE - COLOURS

TECH

trešnja  
*cherry*  
SCH 8R6





**TEMPUS ECONOMY ormari / TEMPUS ECONOMY bookcases**

ZAJEDNIČKA OZNAKA	SLIKA	IZBOR BOJA	DIM.(cm) š d v	OPIS	SASTAV	PAK. kg m3 paketa
ARTICLE CODE	PICTURE	COLOUR SELECTION	DIM.(cm) w d h	DESCRIPTION	ASSEMBLY	PACK. kg m3 col

**ORMARI BEZ ZAVRŠNIH PLOČA ŠIRINE 90 cm, DUBINE 45cm, POLICE I LEĐA ORMARA SIVA SG 263**

**BOOKCASES WITHOUT TOPS WIDTH 90 cm, DEPTH 45 cm, SHELVES AND BACK SIDE COLOUR GREY SG 263**

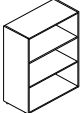
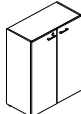
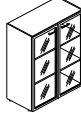
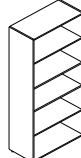
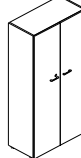

7601 E		TE CH	90 cm	Niski otvoreni ormar 7601 E dimenzije 90x45x79,8h cm s 1 policom	1 x 7601 E	31
			45 cm	Open low bookcase 7601 E dimensions 90x45x79,8h cm with 1 shelf		0,0725
			79,8 cm			2
7602 E		TE CH	90 cm	Niski ormar 7602 E dimenzije 90x45x79,8h cm s drvenim vratima s 1 policom i bravicom	1 x 7602 E	36
			45 cm	Low bookcase 7602 E dimensions 90x45x79,8h cm with wooden doors with 1 shelf and with lock		0,086
			79,8 cm			3
7603 E		TE CH	90 cm	Niski ormar 7603 E dimenzije 90x45x79,8h cm s staklenim vratima s 1 policom bez brave	1 x 7603 E	40
			45 cm	Low bookcase 7603 E dimensions 90x45x79,8h cm with glass doors with 1 shelf without lock		0,0922
			79,8 cm			3
7611 E		TE CH	90 cm	Srednji otvoreni ormar 7611 E dimenzije 90x45x121,6h cm s 2 police	1 x 7611 E	51
			45 cm	Open medium bookcase 7611 E dimensions 90x45x121,6h cm with 2 shelves		0,1425
			121,6 cm			2
7612 E		TE CH	90 cm	Srednji ormar 7612 E dimenzije 90x45x121,6h cm s drvenim vratima s 2 police i bravicom	1 x 7612 E	68
			45 cm	Medium bookcase 7612 E dimensions 90x45x121,6h cm with wooden doors with 2 shelves and with lock		0,1811
			121,6 cm			3
7613 E		TE CH	90 cm	Srednji ormar 7613 E dimenzije 90x45x121,6h cm s staklenim vratima s 2 police bez brave	1 x 7613 E	65
			45 cm	Medium bookcase 7613 E dimensions 90x45x121,6h cm with glass doors with 2 shelves without lock		0,1775
			121,6 cm			3
7621 E		TE CH	90 cm	Visoki otvoreni ormar 7621 E dimenzije 90x45x201,4h cm s 4 police	1 x 7621 E	71
			45 cm	Open high bookcase 7621 E dimensions 90x45x201,4h cm with 4 shelves		0,1625
			201,4 cm			2
7622 E		TE CH	90 cm	Visoki ormar 7622 E dimenzije 90x45x201,4h cm s drvenim vratima s 4 police i bravicom	1 x 7622 E	94
			45 cm	High bookcase 7622 E dimensions 90x45x201,4h cm with wooden doors with 4 shelves and with lock		0,2146
			201,4 cm			3

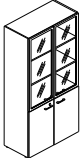
**TEMPUS ECONOMY ormari / TEMPUS ECONOMY bookcases**

ZAJEDNIČKA OZNAKA	SLIKA	IZBOR BOJA	DIM.(cm) š d v	OPIS	SASTAV	PAK. kg m3 paketa
ARTICLE CODE	PICTURE	COLOUR SELECTION	DIM.(cm) w d h	DESCRIPTION	ASSEMBLY	PACK. kg m3 col
7623 E		TE CH	90 cm	Visoki ormar 7623 E dimenzije 90x45x201,4h cm s drvenim i staklenim vratima s 4 police i bravicom	1 x 7623 E	
			45 cm	<i>High bookcase 7623 E dimensions</i>		
			201,4 cm	<i>90x45x201,4h cm with wooden and glass doors with 4 shelves and with lock</i>		

**ORMARI BEZ ZAVRŠNIH PLOČA ŠIRINE 45 cm, DUBINE 45cm, POLICE I LEĐA ORMARA SIVA SG 263**

**BOOKCASES WITHOUT TOPS WIDTH 45 cm, DEPTH 45 cm, SHELVES AND BACK SIDE COLOUR GREY SG 263**

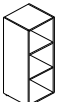
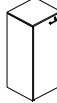
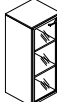
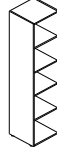
7631 E		TE CH	45 cm	Niski otvoreni ormar 7631 E dimenzije 45x45x79,8h cm s 1 policom	1 x 7631 E	19
			45 cm	<i>Open low bookcase 7631 E dimensions</i>		0,061
			79,8 cm	<i>45x45x79,8h cm with 1 shelf</i>		2
7632D E 7632L E		D TE CH	45 cm	Niski ormar 7632 E dimenzije 45x45x79,8h cm s drvenim vratima s 1 policom i bravicom (lijevi ili desni)	1 x 7632(L/D) E	22
			45 cm	<i>Low bookcase 7632 E dimensions 45x45x79,8h cm with wooden doors with 1 shelf and with lock (left or right)</i>		0,131
			79,8 cm			3
7633D E 7633L E		D TE CH	45 cm	Niski ormar 7633 E dimenzije 45x45x79,8h cm s staklenim vratima s 1 policom bez brave (lijevi ili desni)	1 x 7633(L/D) E	23
			45 cm	<i>Low bookcase 7633 E dimensions 45x45x79,8h cm with glass doors with 1 shelf without lock (left or right)</i>		0,0674
			79,8 cm			3
7641 E		TE CH	45 cm	Srednji otvoreni ormar 7641 E dimenzije 45x45x121,6h cm s 2 police	1 x 7641 E	34
			45 cm	<i>Open medium bookcase 7641 E dimensions</i>		0,1178
			121,6 cm	<i>45x45x121,6h cm with 2 shelves</i>		2
7642L E 7642D E		L TE CH	45 cm	Srednji ormar 7642 E dimenzije 45x45x121,6h cm s drvenim vratima s 2 police i bravicom (lijevi ili desni)	1 x 7642(L/D) E	43
			45 cm	<i>Medium bookcase 7642 E dimensions</i>		0,1379
			121,6 cm	<i>45x45x121,6h cm with wooden doors with 2 shelves and with lock (left or right)</i>		3
7643L E 7643D E		L TE CH	45 cm	Srednji ormar 7643 E dimenzije 45x45x121,6h cm s staklenim vratima s 2 police bez brave (lijevi ili desni)	1 x 7643(L/D) E	42
			45 cm	<i>Medium bookcase 7643 E dimensions</i>		0,1363
			121,6 cm	<i>45x45x121,6h cm with glass doors with 2 shelves without lock (left or right)</i>		3
7651 E		TE CH	45 cm	Visoki otvoreni ormar 7651 E dimenzije 45x45x201,4h cm s 4 police	1 x 7651 E	46
			45 cm	<i>Open high bookcase 7651 E dimensions</i>		0,188
			201,4 cm	<i>45x45x201,4h cm with 4 shelves</i>		2

**TEMPUS ECONOMY ormari / TEMPUS ECONOMY bookcases**

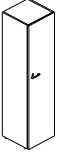
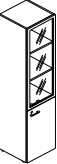
ZAJEDNIČKA OZNAKA	SLIKA	IZBOR BOJA	DIM.(cm) š d v	OPIS	SASTAV	PAK. kg m3 paketa
ARTICLE CODE	PICTURE	COLOUR SELECTION	DIM.(cm) w d h	DESCRIPTION	ASSEMBLY	PACK. kg m3 col
7652L E 7652D E	 D	TE CH	45 cm	Visoki ormar 7652 E dimenzije 45x45x201,4h cm s drvenim vratima s 4 police i bravicom (lijevi ili desni)	1 x 7652(L/D) E	58
			45 cm	<i>High bookcase 7652 E dimensions</i>		0,215
			201,4 cm	<i>45x45x201,4h cm with wooden doors with 4 shelves and with lock (left or right)</i>		3
7653L E 7653D E	 D	TE CH	45 cm	Visoki ormar 7653 E dimenzije 45x45x201,4h cm s drvenim i staklenim vratima s 4 police i bravicom	1 x 7653(L/D) E	
			45 cm	<i>High bookcase 7653 E dimensions</i>		
			201,4 cm	<i>45x45x201,4h cm with wooden and glass doors with 4 shelves and with lock</i>		

**ZAVRŠNE PLOČE ORMARA ŠIRINE 45 i 90 cm**
**TOPS FOR BOOKCASES WIDTH 45 AND 90 cm**

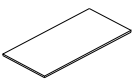
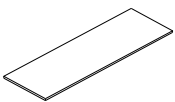
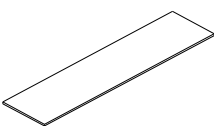
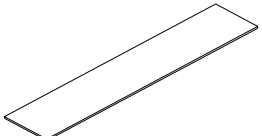
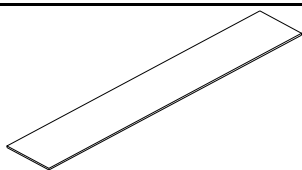

7671 E		TE CH	45 cm	Završna ploča ormara za 1 krilo 7671 E dimenzije 45x45x3,6h cm za ormare širine 45 i 90 cm	1 x 7671 E	3
			45 cm	<i>Top for bookcase for 1 door 7671 E dimensions</i>		0,0055
			3,6 cm	<i>45x45x3,6h cm for bookcases lenght 45 and 90 cm</i>		1
7672 E		TE CH	90 cm	Završna ploča ormara za 2 krila 7672 E dimenzije 90x45x3,6h cm za ormare širine 45 i 90 cm	1 x 7672 E	6
			45 cm	<i>Top for bookcase for 2 doors 7672 E dimensions 90x45x3,6h cm for bookcases</i>		0,0103
			3,6 cm	<i>lenght 45 and 90 cm</i>		1
7673 E		TE CH	135 cm	Završna ploča ormara za 3 krila 7673 E dimenzije 135x45x3,6h cm za ormare širine 45 i 90 cm	1 x 7673 E	9
			45 cm	<i>Top for bookcase for 3 doors 7673 E dimensions 135x45x3,6h cm for bookcases</i>		0,0156
			3,6 cm	<i>lenght 45 and 90 cm</i>		1
7674 E		TE CH	180 cm	Završna ploča ormara za 4 krila 7674 E dimenzije 180x45x3,6h cm za ormare širine 45 i 90 cm	1 x 7674 E	12
			45 cm	<i>Top for bookcase for 4 doors 7674 E dimensions 180x45x3,6h cm for bookcases</i>		0,0205
			3,6 cm	<i>lenght 45 and 90 cm</i>		1
7675 E		TE CH	225 cm	Završna ploča ormara za 5 krila 7675 E dimenzije 225x45x3,6h cm za ormare širine 45 i 90 cm	1 x 7675 E	15
			45 cm	<i>Top for bookcase for 5 doors 7675 E dimensions 225x45x3,6h cm for bookcases</i>		0,0251
			3,6 cm	<i>lenght 45 and 90 cm</i>		1
7676 E		TE CH	270 cm	Završna ploča ormara za 6 krila 7676 E dimenzije 270x45x3,6h cm za ormare širine 45 i 90 cm	1 x 7676 E	18
			45 cm	<i>Top for bookcase for 6 doors 7676 E dimensions 270x45x3,6h cm for bookcases</i>		0,0301
			3,6 cm	<i>lenght 45 and 90 cm</i>		1

**TEMPUS ECONOMY ormari / TEMPUS ECONOMY bookcases**



ZAJEDNIČKA OZNAKA	SLIKA	IZBOR BOJA	DIM.(cm) š d v	OPIS	SASTAV	PAK. kg m3 paketa
ARTICLE CODE	PICTURE	COLOUR SELECTION	DIM.(cm) w d h	DESCRIPTION	ASSEMBLY	PACK. kg m3 col

**PRIMJERI SLOŽENIH KOMPOZICIJA ORMARA ŠIRINE 90 i 45 cm - DODANE SU ZAVRŠNE PLOČE**

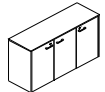
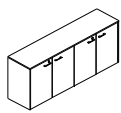
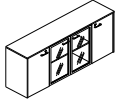
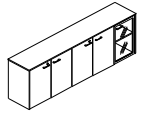
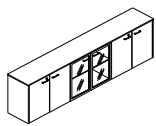
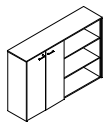
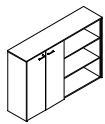
EXAMPLES OF ASSEMBLED COMPOSITIONS BOOKCASES WIDTH 90 AND 45 cm - TOPS ARE ADDED ACCORDINGLY

7901 E		TE CH	94 cm	Kompozicija ormara 7901 E dimenzije 94x45x83,4h cm  <i>Composition of bookcases 7901 E dimensions 94x45x83,4h cm</i>	1 x 7601 E	49
			45 cm		1 x 7672 E	
			83,4 cm		0,1079	
7902 E		TE CH	94 cm	Kompozicija ormara 7902 E dimenzije 94x45x83,4h cm  <i>Composition of bookcases 7902 E dimensions 94x45x83,4h cm</i>	1 x 7603 E	58
			45 cm		1 x 7672 E	
			83,4 cm		0,1276	
7903 E		TE CH	139 cm	Kompozicija ormara 7903 E dimenzije 139x45x83,4h cm  <i>Composition of bookcases 7903 E dimensions 139x45x83,4h cm</i>	1 x 7602 E	79
			45 cm		1 x 7632D E	
			83,4 cm		1 x 7673 E	
7904 E		TE CH	184 cm	Kompozicija ormara 7904 E dimenzije 184x45x83,4h cm  <i>Composition of bookcases 7904 E dimensions 184x45x83,4h cm</i>	2 x 7602 E	96
			45 cm		1 x 7674 E	
			83,4 cm		0,2176	
7905 E		TE CH	184 cm	Kompozicija ormara 7905 E dimenzije 184x45x83,4h cm  <i>Composition of bookcases 7905 E dimensions 184x45x83,4h cm</i>	1 x 7603 E	108
			45 cm		1 x 7632L E	
			83,4 cm		1 x 7632D E	
7906 E		TE CH	184 cm	Kompozicija ormara 7906 E dimenzije 229x45x83,4h cm  <i>Composition of bookcases 7906 E dimensions 229x45x83,4h cm</i>	1 x 7674 E	0,3998
			45 cm		1 x 7674 E	
			83,4 cm		11	
7907 E		TE CH	229 cm	Kompozicija ormara 7906 E dimenzije 229x45x83,4h cm  <i>Composition of bookcases 7906 E dimensions 229x45x83,4h cm</i>	2 x 7602 E	122
			45 cm		1 x 7633D E	
			83,4 cm		1 x 7675 E	
7908 E		TE CH	274 cm	Kompozicija ormara 7907 E dimenzije 274x45x83,4h cm  <i>Composition of bookcases 7907 E dimensions 274x45x83,4h cm</i>	2 x 7602 E	142
			45 cm		1 x 7603 E	
			83,4 cm		1 x 7676 E	
7908 E		TE CH	184 cm	Kompozicija ormara 7908 E dimenzije 184x45x125,2h cm  <i>Composition of bookcases 7908 E dimensions 184x45x125,2h cm</i>	1 x 7611 E	147
			45 cm		1 x 7612 E	
			125,2 cm		1 x 7674 E	
						0,3816
						7

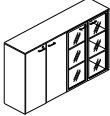
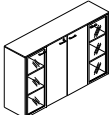
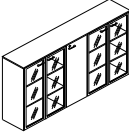
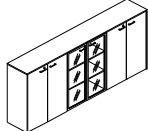
**TEMPUS ECONOMY ormari / TEMPUS ECONOMY bookcases**

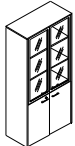
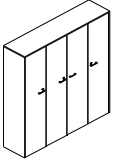
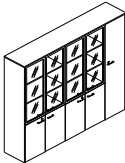
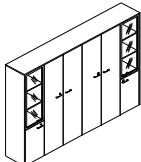
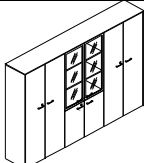
ZAJEDNIČKA OZNAKA	SLIKA	IZBOR BOJA	DIM.(cm) š d v	OPIS	SASTAV	PAK. kg m3 paketa
ARTICLE CODE	PICTURE	COLOUR SELECTION	DIM.(cm) w d h	DESCRIPTION	ASSEMBLY	PACK. kg m3 col
7909 E		TE CH	184 cm	Kompozicija ormara 7909 E dimenzije 184x45x125,2h cm	1 x 7612 E	161
			45 cm		1 x 7613 E	
			125,2 cm	Composition of bookcases 7909 E dimensions 184x45x125,2h cm	1 x 7674 E	
						0,4166
						8
7910 E		TE CH	184 cm	Kompozicija ormara 7910 E dimenzije 184x45x125,2h cm	1 x 7612 E	180
			45 cm		1 x 7643L E	
			125,2 cm	Composition of bookcases 7910 E dimensions 184x45x125,2h cm	1 x 7643D E	
						0,5117
						11
7911 E		TE CH	229 cm	Kompozicija ormara 7911 E dimenzije 229x45x125,2h cm	2 x 7613 E	204
			45 cm		1 x 7642D E	
			125,2 cm	Composition of bookcases 7911 E dimensions 229x45x125,2h cm	1 x 7675 E	
						0,5556
						11
7912 E		TE CH	274 cm	Kompozicija ormara 7912 E dimenzije 274x45x125,2h cm	2 x 7612 E	235
			45 cm		1 x 7613 E	
			125,2 cm	Composition of bookcases 7912 E dimensions 274x45x125,2h cm	1 x 7676 E	
						0,6073
						11
7913D E 7913L E		TE CH	45 cm	Kompozicija ormara 7913 E dimenzije 45x45x205h cm	1 x 7653D E	94
			45 cm		1 x 7671 E	
			205 cm	Composition of bookcases 7913 E dimensions 45x45x205 cm		
						0,3353
						8
7914 E		TE CH	90 cm	Kompozicija ormara 7914 E dimenzije 90x45x205h cm	1 x 7623 E	134
			45 cm		1 x 7672 E	
			205 cm	Composition of bookcases 7914 E dimensions 90x45x205 cm		
						0,3363
						8
7915 E		TE CH	184 cm	Kompozicija ormara 7915 E dimenzije 184x45x205h cm	1 x 7622 E	249
			45 cm		1 x 7652L E	
			205 cm	Composition of bookcases 7915 E dimensions 184x45x205h cm	1 x 7652D E	
						0,7276
						11
7916 E		TE CH	229 cm	Kompozicija ormara 7916 E dimenzije 229x45x205h cm	2 x 76232 E	302
			45 cm		1 x 7652D E	
			205 cm	Composition of bookcases 7916 E dimensions 229x45x205h cm	1 x 7675 E	
						0,8296
						17
7917 E		TE CH	274 cm	Kompozicija ormara 7917 E dimenzije 274x45x205h cm	2 x 7622 E	361
			45 cm		1 x 7653L E	
			205 cm	Composition of bookcases 7917 E dimensions 274x45x205h cm	1 x 7653D E	
						1,0564
						20
7918 E		TE CH	274 cm	Kompozicija ormara 7918 E dimenzije 274x45x205h cm	2 x 7622 E	334
			45 cm		1 x 7623 E	
			205 cm	Composition of bookcases 7918 E dimensions 274x45x205h cm	1 x 7676 E	
						0,7853
						14

**TEMPUS ECONOMY ormari / TEMPUS ECONOMY bookcases**

ZAJEDNIČKA OZNAKA	SLIKA	IZBOR BOJA	DIM.(cm) š d v	OPIS	SASTAV	PAK. kg m3 paketa
ARTICLE CODE	PICTURE	COLOUR SELECTION	DIM.(cm) w d h	DESCRIPTION	ASSEMBLY	PACK. kg m3 col

**ORMARI ŠIRINE 100 cm, DUBINE 45 cm, PREDVIĐENI ZA FORMIRANJE  
KOMODA, POLICE I LEĐA ORMARA SIVA SG 263**  
**BOOKCASES WIDTH 100 cm, DEPTH 45 cm, USED FOR ASSEMBLING BOOKCASES,  
SHELVES AND BACK SIDE COLOUR GREY SG 263**

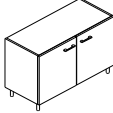
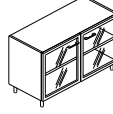
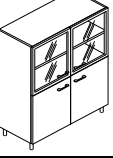
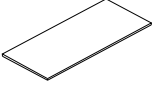
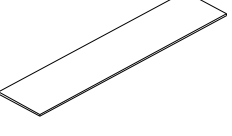
7701 E		TE CH	100 cm	Ormar 7701 E dimenzije 100x45x60h cm s drvenim vratima s 1 policom i bravicom, bez topa	1 x 7701 E	35
			45 cm	Bookcase 7701 E dimensions 100x45x60h cm with wooden doors with 1 shelf and with lock, without top		0,086
			70 cm			3
7702 E		TE CH	100 cm	Ormar 7702 E dimenzije 100x45x60h cm s staklenim vratima s 1 policom bez brave i topa	1 x 7702 E	39
			45 cm	Bookcase 7702 E dimensions 100x45x70h cm with glass doors with 1 shelf without lock and top		0,0922
			70 cm			3
7704 E		TE CH	100 cm	Ormar 7704 E dimenzije 100x45x130h cm s drvenim i staklenim vratima s 3 police bez brave i topa	1 x 7704 E	74
			45 cm	Bookcase 7704 E dimensions 100x45x130h cm with wooden and glass doors with 3 shelves without lock and top		0,1782
			130 cm			3
7771 E		TE CH	100 cm	Završna ploča komode za 2 krila 7771 E dimenzije 100x45x3,6h cm za komode širine 100 cm	1 x 7771 E	7
			45 cm	Top for bookcase for 2 doors 7771 E dimensions 100x45x3,6h cm for bookcases lenght 100 cm		0,0113
			3,6 cm			1
7772 E		TE CH	200 cm	Završna ploča komode za 4 krila 7772 E dimenzije 200x45x3,6h cm za komode širine 100 cm	1 x 7772 E	13
			45 cm	Top for bookcase for 4 doors 7772 E dimensions 200x45x3,6h cm for bookcases lenght 100 cm		0,0221
			3,6 cm			1



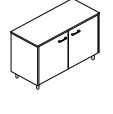
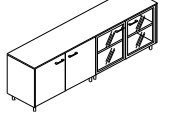

**KOMODE FORMIRANE OD ORMARA ŠIRINE 100 cm I DUBINE 45 cm - DODANE  
SU ZAVRŠNE PLOČE**  
**BOOKCASES FORMED FROM PARTS OF BOOKCASES WIDTH 100 cm AND DEPTH 45 cm -  
TOPS ARE ADDED ACCORDINGLY**

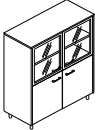
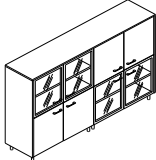
7919 E		TE CH	100 cm	Kompozicija ormara 7919 E dimenzije 100x45x73,6h cm	1 x 7701 E 1 x 7771 E	54
			45 cm			0,1133
			73,6 cm	Composition of bookcases 7919 E dimensions 100x45x73,6h cm		6
7920 E		TE CH	200 cm	Kompozicija ormara 7920 E dimenzije 200x45x73,6h cm	1 x 7701 E 1 x 7702 E 1 x 7772 E	100
			45 cm			0,2163
			73,6 cm	Composition of bookcases 7920 E dimensions 200x45x73,6h cm		10

**TEMPUS ECONOMY ormari / TEMPUS ECONOMY bookcases**

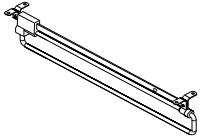
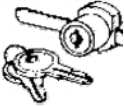
ZAJEDNIČKA OZNAKA	SLIKA	IZBOR BOJA	DIM.(cm) š d v	OPIS	SASTAV	PAK. kg m3 paketa
ARTICLE CODE	PICTURE	COLOUR SELECTION	DIM.(cm) w d h	DESCRIPTION	ASSEMBLY	PACK. kg m3 col
7921 E		TE CH	100 cm	Kompozicija ormara 7921 E dimenzije 100x45x133,6h cm	1 x 7704 E	96
			45 cm	<i>Composition of bookcases 7921 E dimensions</i> 100x45x133,6h cm	1 x 7771 E	
			133,6 cm			
7922 E		TE CH	200 cm	Kompozicija ormara 7922 E dimenzije 200x45x133,6h cm	2 x 7704 E	177
			45 cm	<i>Composition of bookcases 7922 E dimensions</i> 200x45x133,6h cm	1 x 7772 E	
			133,6 cm			

**OSTALI DODACI ZA ORMARE I URED**
**ACCESSORIES FOR BOOKCASES AND OFFICE**

A/HGR		CHROM	36 cm	Izvlačna vješalica za garderobni ormar dimenzije 36x4x6h cm	1 x A/HGR	0,4
			4 cm	<i>Extension hanger for wardrobe dimensions</i> 36x4x6h cm		0,001
			6 cm		1	
A/LCKS		CHROM	2 cm	Bravica za sva staklena vrata ormara dimenzije 2x2x4h cm	1 x A/LCKS	0,2
			2 cm	<i>Lock for all glass doors dimensions 2x2x4h cm</i>		0,0001
			4 cm		1	
SVB		CRNA	56 cm	Samostojeća vješalica GIR CRNA dimenzije 56x56x175h cm	1 x SVB	5
			56 cm	<i>Wardrobe hanger GIR BLACK dimensions</i> 56x56x175h cm		0,0296
			175 cm		1	
SVC		CHROM	56 cm	Samostojeća vješalica GIR CHROM dimenzije 56x56x175h cm	1 x SVC	5
			56 cm	<i>Wardrobe hanger GIR CHROM</i> dimensions 56x56x175h cm		0,0296
			175 cm		1	
KZS		CRNA	28 cm	Koš za smeće žičani dimenzije Ø28x35h cm	1 x KZS	0,5
			28 cm	<i>Trash basket dimensions</i> Ø28x35h cm		0,0361
			35 cm		1	

**TEHNIČKI OPIS**

**TECHNICAL DESCRIPTION**

**ORMARI**  
**BOOKCASES**

Izrađeni su od melaminskih panela u debljinama kako slijedi: bočne stranice, vrata i završna ploča 18 mm; police 25 mm. Svi rubovi ormara (uključujući i police) su kantirani ABS rubnom trakom. Police i leđa ormara su u sivoj boji, dok su vrata ormara, bočne stranice i završna ploča u boji namještaja. Ormari su opremljeni nožicama za regulaciju visine podesivim iznutra. Staklena vrata su debljine 5 mm. Drvena vrata standardno su opremljena sa bravicom, kod staklenih je to opcija. Kao opcije se mogu dobiti i dodatne police za ormar.

*Bookcases are made of melamine panels in thickness as follows: side panels, fronts, tops and back side 18mm; shelves 25 mm. All edges of bookcase (including shelves) are covered with ABS tape. Shelves and back side are in gray colour, while the fronts, side panels and tops are made in colour of the furniture. Bookcases are equipped with legs for height regulation that are adjustable from the inside. Glass doors have thickness of 5mm. Wooden fronts are equipped with locks as standard, on glass doors lock is an option. Additional shelves can be delivered as option too.*

**NAPOMENA U VEZI IZBORA BOJA**  
**REMARK ABOUT COLOURS**

Navedene boje u našoj ponudi su uvijek identične u svakoj isporuci. Međutim naziv (trešnja, javor i sl.) niti približno ne definira boju iverala. Na tržištu se mogu pojaviti stotine različitih varijacija pod oznakom npr. trešnja, a što je posljedica uzgoja ovog drveta u vrlo različitim klimatskim uvjetima. Isto tako i boje siva, antracit i sl. mogu se pojaviti u puno različitih nijansi. Zbog navedenog razloga na našim dostavnim dokumentima navodimo klauzulu: "Reklamaciju na vaš odabir boja nakon isporuke ne prihvaćamo".

*Available colours in our assortment are identical in every delivery. However, the name (cherry, maple etc.) does not indicate the exact design. There are hundreds of different variations under the name for example cherry, which is caused by growing of cherry tree in different climate conditions. Uni colours like gray, anthracite etc. can also be in different designs. Due to above stated there is a remark on our delivery documentation: "After delivery, complaint on your selection of colours will not be accepted"*