

TREND ECONOMY metalne noge

TREND ECONOMY metal legs

(Topovi stolova debljine 25mm / *desktop 25mm thick*)



BOJE - COLOURS

SB

bukva
beech
SBE 83B

SW TRE

orah
walnut
SW 4L8

CH TRE

trešnja
cherry
SCH 8H7



TREND ECONOMY metalne noge / TREND ECONOMY metal legs

ZAJEDNIČKA OZNAKA	SLIKA	IZBOR BOJA	DIM.(cm) š d v	OPIS	SASTAV	PAK. kg m3 paketa
ARTICLE CODE	PICTURE	COLOUR SELECTION	DIM.(cm) w d h	DESCRIPTION	ASSEMBLY	PACK. kg m3 col

PRAVOKUTNI RADNI STOLOVI (DEBLJINA TOPOVA 25 mm)
RECTANGULAR WORK TABLES (DESKTOP 25 mm THICK)

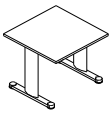
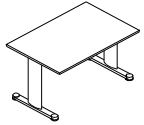
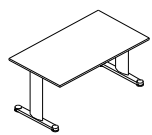
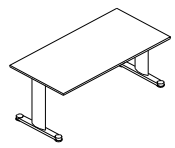
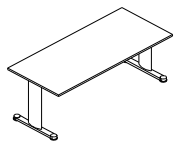
3101 E		SB CH TR E SW TR E	80 cm	Pravokutni radni stol 3101 E dimenzije 80x80x72h cm s sivim metalnim nogama <i>Rectangular work table 3101 E dimensions 80x80x72h cm with grey metal legs</i>	1 x 3101 E	25
			80 cm			0,1573
			72 cm			4
3102 E		SB CH TR E SW TR E	120 cm	Pravokutni radni stol 3102 E dimenzije 120x80x72h cm s sivim metalnim nogama <i>Rectangular work table 3102 E dimensions 120x80x72h cm with grey metal legs</i>	1 x 3102 E	31
			80 cm			0,1805
			72 cm			4
3103 E		SB CH TR E SW TR E	140 cm	Pravokutni radni stol 3103 E dimenzije 140x80x72h cm s sivim metalnim nogama <i>Rectangular work table 3103 E dimensions 140x80x72h cm with grey metal legs</i>	1 x 3103 E	35
			80 cm			0,1909
			72 cm			4
3104 E		SB CH TR E SW TR E	160 cm	Pravokutni radni stol 3104 E dimenzije 160x80x72h cm s sivim metalnim nogama <i>Rectangular work table 3104 E dimensions 160x80x72h cm with grey metal legs</i>	1 x 3104 E	38
			80 cm			0,2013
			72 cm			4
3105 E		SB CH TR E SW TR E	180 cm	Pravokutni radni stol 3105 E dimenzije 180x80x72h cm s sivim metalnim nogama <i>Rectangular work table 3105 E dimensions 180x80x72h cm with grey metal legs</i>	1 x 3105 E	41
			80 cm			0,2071
			72 cm			4

DODACI RADNIM STOLOVIMA (DEBLJINA TOPOVA 25 mm)
WORK TABLE ENDS (DESKTOP 25 mm THICK)

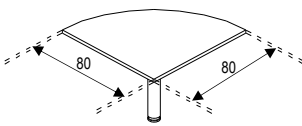
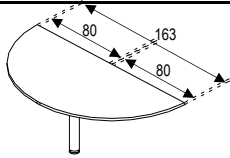
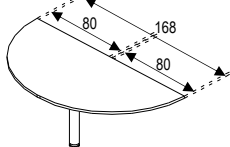
3141 E		SB CH TR E SW TR E	80 cm	Kutni dodatak 90° 3141 E dimenzije 80x80x72h cm sa okruglom sivom metalnom nogom za radni stol <i>Angle 90° 3141 E dimensions 80x80x72h cm with round grey metal leg for work table</i>	1 x 3141 E	13
			80 cm			0,0491
			72 cm			2
3142 E		SB CH TR E SW TR E	80 cm	Dodatak 3142 E dimenzije 80x163x72h cm sa okruglom sivom metalnom nogom za dva radna stola <i>Shaped end 3142 E dimensions 80x163x72h cm with round grey metal leg for two work tables</i>	1 x 3142 E	23
			163 cm			0,1012
			72 cm			2
3148 E		SB CH TR E SW TR E	80 cm	Dodatak 3148 E dimenzije 80x163x72h cm sa okruglom sivom metalnom nogom za dva radna stola s pregradom <i>Shaped end 3148 E dimensions 80x163x72h cm with round grey metal leg for two work tables with partition panel</i>	1 x 3148 E	23
			168 cm			0,1012
			72 cm			2

TREND ECONOMY metalne noge / TREND ECONOMY metal legs

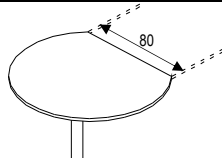
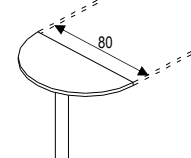
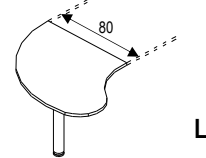
ZAJEDNIČKA OZNAKA	SLIKA	IZBOR BOJA	DIM.(cm) š d v	OPIS	SASTAV	PAK. kg m3 paketa
ARTICLE CODE	PICTURE	COLOUR SELECTION	DIM.(cm) w d h	DESCRIPTION	ASSEMBLY	PACK. kg m3 col
3143 E		SB CH TR E SW TR E	93 cm	Konferencijski dodatak 3143 E dimenzije 93x110x72h cm sa okruglom sivom met. nogom za radni stol	1 x 3143 E	19
			110 cm	<i>Tear-drop end 3143 E dimensions 93x110x72h cm with round grey metal leg for work table</i>		0,0648
			72 cm			2
3144 E		SB CH TR E SW TR E	40 cm	Mali konferencijski dodatak 3144 E dimenzije 40x80x72h cm sa okruglom sivom metalnom nogom za radni stol	1 x 3144 E	8
			80 cm	<i>Small round end 3144 E dimensions</i>		0,0354
			72 cm	<i>40x80x72h cm with round grey metal leg for work table</i>		2
3145L E 3145D E		SB CH TR E SW TR E	80 cm	Kontakt nastavak 3145 E (L ili D) dimenzije 80x111x72h cm sa okruglom sivom metalnom nogom za radni stol (lijevi ili desni)	1 x 3145 E (L/D)	16
			111 cm	<i>Tear-drop end 3145 E (L ili D) dimensions</i>		0,0644
			72 cm	<i>80x111x72h cm with round grey metal leg for work table (left or right)</i>		2



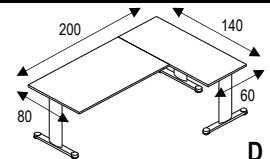
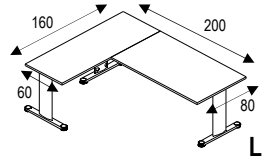
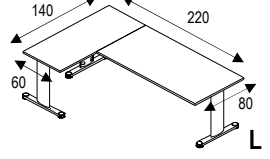
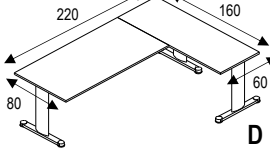
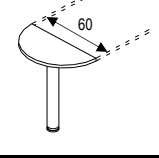
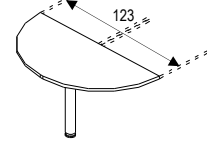

KOMPAKT RADNI STOLOVI (DEBLJINA TOPOVA 25 mm)
COMPACT WORK TABLES (DESKTOP 25 mm THICK)

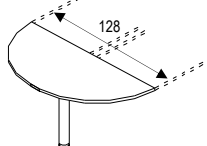
3109L E 3109D E		SB CH TR E SW TR E	200 cm	Kompakt radni stol 3109 E sivim metalnim nogama (lijevi ili desni)	1 x 3109 E (L/D)	63
			140 cm	<i>Compact work table 3109 Egrey metal legs (left or right)</i>		0,3243
			72 cm			7
3110L E 3110D E		SB CH TR E SW TR E	200 cm	Kompakt radni stol 3110 E sivim metalnim nogama (lijevi ili desni)	1 x 3110 E (L/D)	66
			160 cm	<i>Compact work table 3110 Egrey metal legs (left or right)</i>		0,3368
			72 cm			7
3111L E 3111D E		SB CH TR E SW TR E	220 cm	Kompakt radni stol 3111 E sivim metalnim nogama (lijevi ili desni)	1 x 3111 E (L/D)	66
			140 cm	<i>Compact work table 3111 Egrey metal legs (left or right)</i>		0,3325
			72 cm			7
3112L E 3112D E		SB CH TR E SW TR E	220 cm	Kompakt radni stol 3112 E sivim metalnim nogama (lijevi ili desni)	1 x 3112 E (L/D)	69
			160 cm	<i>Compact work table 3112 Egrey metal legs (left or right)</i>		0,345
			72 cm			7
3146 E (UZ ARTIKLE/ WITH ARTICLES 3109, 3110, 3111, 3112)		SB CH TR E SW TR E	30 cm	Mali konferencijski dodatak 3146 E dimenzije 30x60x72h cm sa okruglom sivom metalnom nogom za radni stol	1 x 3146 E	6
			60 cm	<i>Small round end 3146 E dimensions</i>		0,0328
			72 cm	<i>30x60x72h cm with round grey metal leg for work table</i>		2
3147 E (UZ ARTIKLE/ WITH ARTICLES 3109, 3110, 3111, 3112)		SB CH TR E SW TR E	60 cm	Mali konferencijski dodatak 3147 E dimenzije 60x123x72h cm sa okruglom sivom met. nogom za radni stol	1 x 3147 E	16
			123 cm	<i>Small round end 3147 E dimensions</i>		0,0621
			72 cm	<i>60x123x72h cm with round grey metal leg for work table</i>		2

TREND ECONOMY metalne noge / TREND ECONOMY metal legs

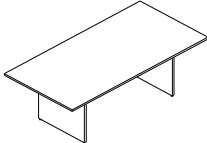
ZAJEDNIČKA OZNAKA	SLIKA	IZBOR BOJA	DIM.(cm) š d v	OPIS	SASTAV	PAK. kg m3 paketa
ARTICLE CODE	PICTURE	COLOUR SELECTION	DIM.(cm) w d h	DESCRIPTION	ASSEMBLY	PACK. kg m3 col
3149 E (UZ ARTIKLE/ WITH ARTICLES 3109, 3110, 3111, 3112)		SB CH TR E SW TR E	60 cm	Mali konferencijski dodatak 3149 E dimenzije 60x128x72h cm sa okruglom sivom met. nogom za radni stol s pregradom	1 x 3149 E	16
			128 cm	<i>Small round end 3149 E dimensions</i>		0,0621
			72 cm	<i>60x128x72h cm with round grey metal leg for work table with partition panel</i>		2

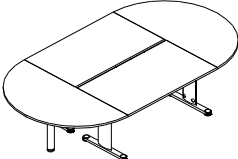
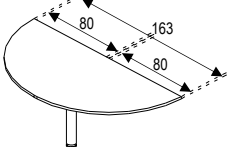
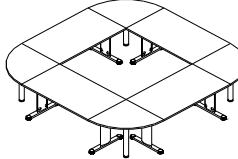
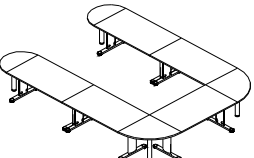
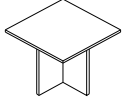
KONFERENCIJSKI STOLOVI I KLUB STOLIĆI (DEBLJINA TOPOVA 25 mm)
CONFERENCE TABLES AND TABLES FOR WAITING ROOM (DESKTOP 25 mm THICK)

3071 E		SB CH TR E SW TR E	200 cm	Konferencijski stol 3071 E dimenzije 200x100x72h cm s drvenim nogama	1 x 3071 E	57
			100 cm	<i>Conference table 3071 E dimensions</i>		0,2083
			72 cm	<i>200x100x72h cm with wooden legs</i>		2
3072 E		SB CH TR E SW TR E	110 cm	Okrugli konferencijski stol 3072 E dimenzije Ø110x72h cm s drvenim nogama	1 x 3072 E	32
			110 cm	<i>Round conference table 3072 E dimensions</i>		0,117
			72 cm	<i>Ø110x72h cm with wooden legs</i>		1
3971 E		SB CH TR E SW TR E	300 cm	Kompozicija konferencijskog stola 3971 E dimenzije 300x163x72h cm	2 x 3103 E 2 x 3142 E	116
			163 cm	<i>Composition of conference table 3971 E dimensions 300x163x72h cm</i>		0,5842
			72 cm			12
3142 E		SB CH TR E SW TR E	80 cm	Dodatak 3142 E dimenzije 80x163x72h cm sa okruglom sivom metalnom nogom za dva radna stola	1 x 3142 E	23
			163 cm	<i>Shaped end 3142 E dimensions 80x163x72h cm with round grey metal leg for two work tables</i>		0,1012
			72 cm			2
3972 E		SB CH TR E SW TR E	300 cm	Kompozicija konferencijskog stola 3972 E dimenzije 300x300x72h cm	4 x 3103 E 4 x 3141 E	192
			300 cm	<i>Composition of conference table 3972 E dimensions 300x300x72h cm</i>		0,96
			72 cm			24
3973 E		SB CH TR E SW TR E	400 cm	Kompozicija konferencijskog stola 3973 E dimenzije 400x300x72h cm	5 x 3103 E 2 x 3141 E 2 x 3144 E	217
			300 cm	<i>Composition of conference table 3973 E dimensions 400x300x72h cm</i>		1,1235
			72 cm			18
3073 E		SB CH TR E SW TR E	60 cm	Kvadratni klub stolić 3073 E dimenzije 60x60x50h cm s drvenim nogama	1 x 3073 E	15
			60 cm	<i>Square table for waiting room 3073 E dimensions 60x60x50h cm with wooden legs</i>		0,0333
			50 cm			1
3074 E		SB CH TR E SW TR E	60 cm	Okrugli klub stolić 3074 E dimenzije Ø60x50h cm s drvenim nogama	1 x 3074 E	14
			60 cm	<i>Round table for waiting room 3074 E dimensions Ø60x50h cm with wooden legs</i>		0,0357
			50 cm			1

TREND ECONOMY metalne noge / TREND ECONOMY metal legs

ZAJEDNIČKA OZNAKA	SLIKA	IZBOR BOJA	DIM.(cm) š d v	OPIS	SASTAV	PAK. kg m3 paketa
ARTICLE CODE	PICTURE	COLOUR SELECTION	DIM.(cm) w d h	DESCRIPTION	ASSEMBLY	PACK. kg m3 col

DRVENI IZVLAČNI NOSAČ TIPKOVNICE
WOODEN SLIDING KEYBOARD HOLDER

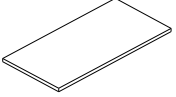
3092 E		SB CH TR E SW TR E	64,5 cm	Drveni izvlačni nosač tipkovnice 3092 E dimenzije 64,5x36x1,8h cm za sve radne stolove	1 x 3092 E	3
			36 cm	Wooden sliding keyboard holder 3092 E dimensions 64,5x36x1,8h cm for all work tables		0,0078
			1,8 cm			1

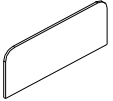
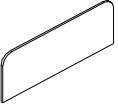
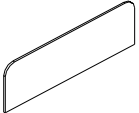
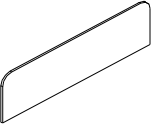
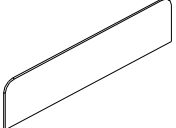
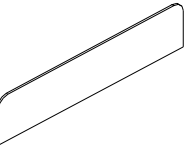

RAVNE PREGRADE ZA KOMBINACIJU S 2 RADNA STOLA
FLAT PARTITION PANELS FOR COMBINATION WITH 2 WORK TABLES

3059 E		SB CH TR E SW TR E	80 cm	Ravna pregrada 3059 E dimenzije 80x1,8x40h cm za dužinu 80 cm (bez nosača)	1 x 3059 E	4
			1,8 cm	Flat partition panel 3059 E dimensions 80x1,8x40h cm for length 80 cm (without holders)		0,0076
			40 cm			1
3060 E		SB CH TR E SW TR E	110 cm	Ravna pregrada 3060 E dimenzije 110x1,8x40h cm za dužinu 110 cm (bez nosača)	1 x 3060 E	6
			1,8 cm	Flat partition panel 3060 E dimensions 110x1,8x40h cm for length 110 cm (without holders)		0,0103
			40 cm			1
3061 E		SB CH TR E SW TR E	120 cm	Ravna pregrada 3061 E dimenzije 120x1,8x40h cm za dužinu 120 cm (bez nosača)	1 x 3061 E	6
			1,8 cm	Flat partition panel 3061 E dimensions 120x1,8x40h cm for length 120 cm (without holders)		0,0112
			40 cm			1
3062 E		SB CH TR E SW TR E	140 cm	Ravna pregrada 3062 E dimenzije 140x1,8x40h cm za dužinu 140 cm (bez nosača)	1 x 3062 E	7
			1,8 cm	Flat partition panel 3062 E dimensions 140x1,8x40h cm for length 140 cm (without holders)		0,013
			40 cm			1
3063 E		SB CH TR E SW TR E	160 cm	Ravna pregrada 3063 E dimenzije 160x1,8x40h cm za dužinu 160 cm (bez nosača)	1 x 3063 E	8
			1,8 cm	Flat partition panel 3063 E dimensions 160x1,8x40h cm for length 160 cm (without holders)		0,0148
			40 cm			1
3064 E		SB CH TR E SW TR E	180 cm	Ravna pregrada 3064 E dimenzije 180x1,8x40h cm za dužinu 180 cm (bez nosača)	1 x 3064 E	9
			1,8 cm	Flat partition panel 3064 E dimensions 180x1,8x40h cm for length 180 cm (without holders)		0,0166
			40 cm			1
3065 E		SB CH TR E SW TR E	200 cm	Ravna pregrada 3065 E dimenzije 200x1,8x40h cm za dužinu 200 cm (bez nosača)	1 x 3065 E	10
			1,8 cm	Flat partition panel 3065 E dimensions 200x1,8x40h cm for length 200 cm (without holders)		0,0184
			40 cm			1

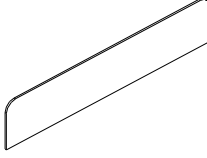
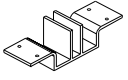
TREND ECONOMY metalne noge / TREND ECONOMY metal legs

ZAJEDNIČKA OZNAKA	SLIKA	IZBOR BOJA	DIM.(cm) š d v	OPIS	SASTAV	PAK. kg m3 paketa
ARTICLE CODE	PICTURE	COLOUR SELECTION	DIM.(cm) w d h	DESCRIPTION	ASSEMBLY	PACK. kg m3 col
3066 E		SB CH TR E SW TR E	220 cm	Ravna pregrada 3066 E dimenzije 220x1,8x40h cm za dužinu 220 cm (<u>bez nosača</u>)	1 x 3066 E	11
			1,8 cm	Flat partition panel 3066 E dimensions		0,0202
			40 cm	220x1,8x40h cm for length 220 cm (<u>without holders</u>)		1
3067		RAL 9006	20 cm	Nosač 3067 dimenzije 20x6x6,5h cm za pregradu, sivi NAPOMENA: kod dužina do 140cm 2 kom, a 140cm i više 3 kom	1 x 3067	0,01
			6 cm	Support 3067 dimensions 20x6x6,5h cm for		0,001
			6,5 cm	partition panel, grey REMARK: for length to 140cm 2 pcs, 140cm and more 3 pcs		1

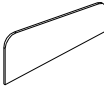
KOSE PREGRADE ZA KOMBINACIJU S 4 RADNA STOLA
SLOPE PARTITION PANELS FOR COMBINATION WITH 4 WORK TABLES

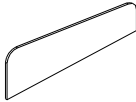
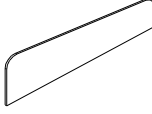
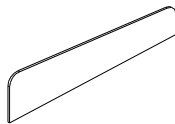
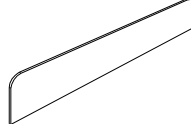
3051 E		SB CH TR E SW TR E	80 cm	Kosa pregrada 3051 E dimenzije 80x1,8x40h cm za dužinu 80 cm (<u>bez nosača</u>)	1 x 3051 E	3,5
			1,8 cm	Slope partition panel 3051 E dimensions		0,0068
			40 cm	80x1,8x40h cm for length 80 cm (<u>without holders</u>)		1
3052 E		SB CH TR E SW TR E	110 cm	Kosa pregrada 3052 E dimenzije 110x1,8x40h cm za dužinu 110 cm (<u>bez nosača</u>)	1 x 3052 E	5
			1,8 cm	Slope partition panel 3052 E dimensions		0,0092
			40 cm	110x1,8x40h cm for length 110 cm (<u>without holders</u>)		1
3053 E		SB CH TR E SW TR E	120 cm	Kosa pregrada 3053 E dimenzije 120x1,8x40h cm za dužinu 120 cm (<u>bez nosača</u>)	1 x 3053 E	5,5
			1,8 cm	Slope partition panel 3053 E dimensions		0,01
			40 cm	120x1,8x40h cm for length 120 cm (<u>without holders</u>)		1
3054 E		SB CH TR E SW TR E	140 cm	Kosa pregrada 3054 E dimenzije 140x1,8x40h cm za dužinu 140 cm (<u>bez nosača</u>)	1 x 3054 E	6,5
			1,8 cm	Slope partition panel 3054 E dimensions		0,012
			40 cm	140x1,8x40h cm for length 140 cm (<u>without holders</u>)		1
3055 E		SB CH TR E SW TR E	160 cm	Kosa pregrada 3055 E dimenzije 160x1,8x40h cm za dužinu 160 cm (<u>bez nosača</u>)	1 x 3055 E	7,5
			1,8 cm	Slope partition panel 3055 E dimensions		0,013
			40 cm	160x1,8x40h cm for length 160 cm (<u>without holders</u>)		1
3056 E		SB CH TR E SW TR E	180 cm	Kosa pregrada 3056 E dimenzije 180x1,8x40h cm za dužinu 180 cm (<u>bez nosača</u>)	1 x 3056 E	8
			1,8 cm	Slope partition panel 3056 E dimensions		0,015
			40 cm	180x1,8x40h cm for length 180 cm (<u>without holders</u>)		1
3057 E		SB CH TR E SW TR E	200 cm	Kosa pregrada 3057 E dimenzije 200x1,8x40h cm za dužinu 200 cm (<u>bez nosača</u>)	1 x 3057 E	9
			1,8 cm	Slope partition panel 3057 E dimensions		0,017
			40 cm	200x1,8x40h cm for length 200 cm (<u>without holders</u>)		1

TREND ECONOMY metalne noge / TREND ECONOMY metal legs

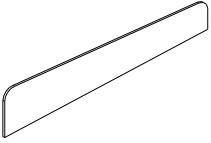
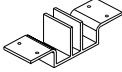
ZAJEDNIČKA OZNAKA	SLIKA	IZBOR BOJA	DIM.(cm) š d v	OPIS	SASTAV	PAK. kg m3 paketa
ARTICLE CODE	PICTURE	COLOUR SELECTION	DIM.(cm) w d h	DESCRIPTION	ASSEMBLY	PACK. kg m3 col
3058 E		SB CH TR E SW TR E	220 cm	Kosa pregrada 3058 E dimenzije 220x1,8x40h cm za dužinu 220 cm (<u>bez nosača</u>)	1 x 3058 E	10
			1,8 cm	Slope partition panel 3058 E dimensions 220x1,8x40h cm for length 220 cm (<u>without holders</u>)		0,018
			40 cm			1
3067		RAL 9006	20 cm	Nosač 3067 dimenzije 20x6x6,5h cm za pregradu, sivi NAPOMENA: kod dužina do 140cm 2 kom, a 140cm i više 3 kom	1 x 3067	0,01
			6 cm	Support 3067 dimensions 20x6x6,5h cm for partition panel, grey		0,001
			6,5 cm	REMARK: for length to 140cm 2 pcs, 140cm and more 3 pcs		1

PREDNJE PLOČE ZA RADNE STOLOVE
FRONTAL PANELS FOR WORK TABLES

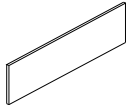
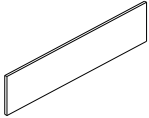
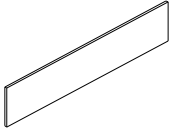
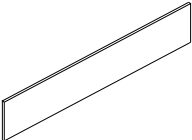
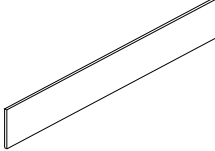
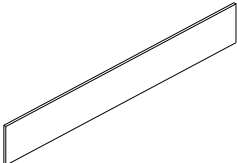
3191 E		SB CH TR E SW TR E	62 cm	Prednja ploča 3191 E dimenzije 62x1,8x32h cm za radni stol 3101 <u>bez nosača</u>	1 x 3191 E	2,5
			1,8 cm	Frontal panel 3191 E dimensions 62x1,8x32h cm for work table 3101 <u>without holder</u>		0,0056
			32 cm			1
3192 E		SB CH TR E SW TR E	102 cm	Prednja ploča 3192 E dimenzije 102x1,8x32h cm za radni stol 3102 <u>bez nosača</u>	1 x 3192 E	4
			1,8 cm	Frontal panel 3192 E dimensions 102x1,8x32h cm for work table 3102 <u>without holder</u>		0,0088
			32 cm			1
3193 E		SB CH TR E SW TR E	122 cm	Prednja ploča 3193 E dimenzije 122x1,8x32h cm za radni stol 3103 <u>bez nosača</u>	1 x 3193 E	5
			1,8 cm	Frontal panel 3193 E dimensions 122x1,8x32h cm for work table 3103 <u>without holder</u>		0,0104
			32 cm			1
3194 E		SB CH TR E SW TR E	142 cm	Prednja ploča 3194 E dimenzije 142x1,8x32h cm za radni stol 3104 <u>bez nosača</u>	1 x 3194 E	6
			1,8 cm	Frontal panel 3194 E dimensions 142x1,8x32h cm for work table 3104 <u>without holder</u>		0,012
			32 cm			1
3195 E		SB CH TR E SW TR E	162 cm	Prednja ploča 3195 E dimenzije 162x1,8x32h cm za radni stol 3105 <u>bez nosača</u>	1 x 3195 E	7
			1,8 cm	Frontal panel 3195 E dimensions 162x1,8x32h cm for work table 3105 <u>without holder</u>		0,0136
			32 cm			1
3196 E		SB CH TR E SW TR E	182 cm	Prednja ploča 3196 E dimenzije 182x1,8x32h cm za radne stolove 3109 i 3110 <u>bez nosača</u>	1 x 3196 E	8
			1,8 cm	Frontal panel 3196 E dimensions 182x1,8x32h cm for work tables 3109 and 3110 <u>without holder</u>		0,0152
			32 cm			1
3197 E		SB CH TR E SW TR E	202 cm	Prednja ploča 3197 E dimenzije 202x1,8x32h cm za radne stolove 3111 i 3112 <u>bez nosača</u>	1 x 3197 E	9
			1,8 cm	Frontal panel 3197 E dimensions 202x1,8x32h cm for work tables 3111 i 3112 <u>without holder</u>		0,0168
			32 cm			1

TREND ECONOMY metalne noge / TREND ECONOMY metal legs

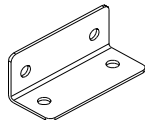
ZAJEDNIČKA OZNAKA	SLIKA	IZBOR BOJA	DIM.(cm) š d v	OPIS	SASTAV	PAK. kg m3 paketa
ARTICLE CODE	PICTURE	COLOUR SELECTION	DIM.(cm) w d h	DESCRIPTION	ASSEMBLY	PACK. kg m3 col
3198		RAL 9006	8 cm	Nosač 3198 dimenzije 8x3,5x3,5h cm za prednju ploču, sivi NAPOMENA: kod dužina do 140cm 2 kom, a 140cm i više 3 kom Support 3198 dimensions 8x3,5x3,5h cm for front panel, grey REMARK: for length to 140cm 2 pcs, 140cm and more 3 pcs	1 x 3198	0,01
			3,5 cm			0,001
			3,5 cm			1

**LADIČARI
CHEST OF DRAWERS**

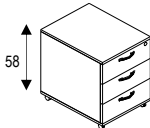
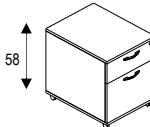
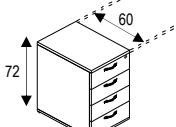
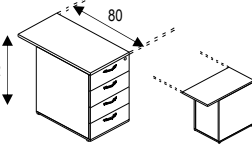
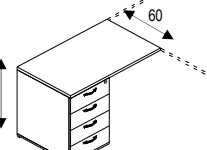
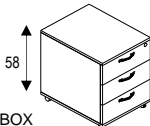
3501 E		SB CH TR E SW TR E	43 cm	Pokretna kazeta 3501 E dimenzije 43x55x58h cm s 3 drvene ladice i dodatnom ladicom za писаči прибор Chest of drawers 3501 E dimensions 43x55x58h cm with 3 wooden drawers and additional pen tray	1 x 3501 E	20
			55 cm			0,1521
			58 cm			1
3503 E		SB CH TR E SW TR E	43 cm	Pokretna kazeta za viseće mape 3503 E dimenzije 43x55x58h cm s 1 drvenom ladicom + dodatnom ladicom za писаči прибор i 1 ladicom za viseće mape Filing chest of drawers 3503 E dimensions 43x55x58h cm with 1 wooden drawer + additional pen tray and 1 filing drawer	1 x 3503 E	20
			55 cm			0,1521
			58 cm			1
3505 E (UZ ARTIKLE/ WITH ARTICLES 3109, 3110, 3111, 3112)		SB CH TR E SW TR E	43 cm	Fiksna kazeta kao dodatak radnom stolu 3505 E dimenzije 43x60x72h cm s 4 drvene ladice i dodatnom ladicom za писаči прибор - top 25mm Fixed chest of drawers like table end 3505 E dimensions 43x60x72h cm with 4 wooden drawers and additional pen tray - top 25mm	1 x 3505 E	28
			60 cm			0,2028
			72 cm			1
3506 E		SB CH TR E SW TR E	43 cm	Fiksna kazeta kao dodatak radnom stolu 3506 E dimenzije 43x80x72h cm s 4 drvene ladice i dodatnom ladicom za писаči прибор - top 25mm Fixed chest of drawers like table end 3506 E dimensions 43x80x72h cm with 4 wooden drawers and additional pen tray - top 25mm	1 x 3506 E	36
			80 cm			0,2626
			72 cm			2
3507 E		SB CH TR E SW TR E	100 cm	Fiksna kazeta kao dodatak radnom stolu 3507 E dimenzije 100x60x72h cm s 4 drvene ladice i dodatnom ladicom za писаči прибор - top 25mm Fixed chest of drawers like table end 3507 E dimensions 100x60x72h cm with 4 wooden drawers and additional pen tray - top 25mm	1 x 3507 E	35
			60 cm			0,2239
			72 cm			2
3502 E		SB CH TR E SW TR E	43 cm	Pokretna kazeta 3502 E dimenzije 43x55x58h cm s 3 metabox i dodatnom ladicom za писаči прибор Chest of drawers 3502 E dimensions 43x55x58h cm with 3 metabox drawers and additional pen tray	1 x 3502 E	21
			55 cm			0,1521
			58 cm			1

PRIMJERI SLOŽENIH KOMPOZICIJA GDJE JE GLAVNI RADNI STOL DUŽINE 160 cm.
(u slučaju potrebe izmjeniti u specifikaciji šifru glavnog stola, moguće dužine 140 ili 180 cm)*
EXAMPLES OF COMPOSITIONS WITH THE MAIN DESK IN LENGTH 160 cm.
(in case of different dimensions please change the code of main desk in the specification of composition, another available lengths are 140 or 180 cm)*

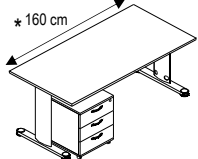
3952 E		SB CH TR E SW TR E	160 cm	Kompozicija 3952 E dimenzije 160x80x72h cm za 1 radno mjesto Composition 3952 E dimensions 160x80x72h cm for 1 workplace	1 x 3104 E*	58
			80 cm			0,3534
			72 cm			5

TREND ECONOMY metalne noge / TREND ECONOMY metal legs

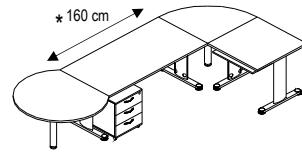
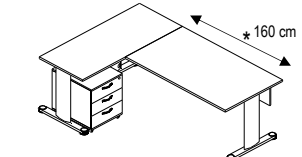
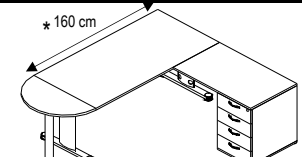
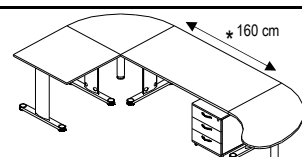
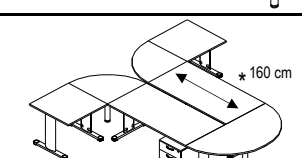
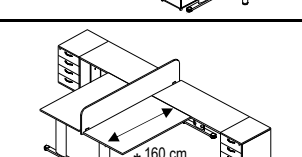
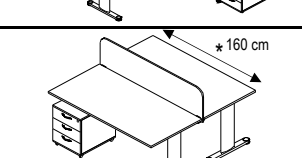
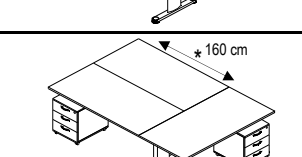
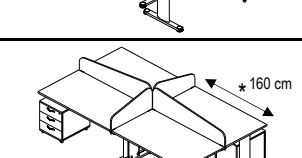
ZAJEDNIČKA OZNAKA	SLIKA	IZBOR BOJA	DIM.(cm) š d v	OPIS	SASTAV	PAK. kg m3 paketa
ARTICLE CODE	PICTURE	COLOUR SELECTION	DIM.(cm) w d h	DESCRIPTION	ASSEMBLY	PACK. kg m3 col
3953 E		SB CH TR E SW TR E	333 cm	Kompozicija 3953 E dimenzije 333x160x72h cm za 1 radno mjesto <i>Composition 3953 E dimensions 333x160x72h cm for 1 workplace</i>	1 x 3104 E*	118
			160 cm		1 x 3101 E	
			72 cm		1 x 3141 E 1 x 3143 E 1 x 3092 E 1 x 3501 E	
3955 E		SB CH TR E SW TR E	200 cm	Kompozicija 3955 E dimenzije 200x140x72h cm za 1 radno mjesto <i>Composition 3955 E dimensions 200x140x72h cm for 1 workplace</i>	1 x 3109L E*	91
			140 cm		1 x 3196 E 3 x 3198	
			72 cm		1 x 3501 E	
3956 E		SB CH TR E SW TR E	200 cm	Kompozicija 3956 E dimenzije 200x180x72h cm za 1 radno mjesto <i>Composition 3956 E dimensions 200x180x72h cm for 1 workplace</i>	1 x 3104 E*	81
			180 cm		1 x 3144 E 1 x 3507 E	
			72 cm			
3957 E		SB CH TR E SW TR E	320 cm	Kompozicija 3957 E dimenzije 320x160x72h cm za 1 radno mjesto <i>Composition 3957 E dimensions 320x160x72h cm for 1 workplace</i>	1 x 3104 E*	112
			160 cm		1 x 3101 E 1 x 3141 E 1 x 3145D E	
			72 cm		1 x 3501 E	
3958 E		SB CH TR E SW TR E	320 cm	Kompozicija 3958 E dimenzije 320x323x72h cm za 2 radna mjesta <i>Composition 3958 E dimensions 320x323x72h cm for 2 workplaces</i>	2 x 3104 E*	215
			323 cm		2 x 3101 E 2 x 3141 E 1 x 3142 E	
			72 cm		2 x 3501 E	
3960 E		SB CH TR E SW TR E	200 cm	Kompozicija 3960 E dimenzije 200x375x72h cm za 2 radna mjesta <i>Composition 3960 E dimensions 200x375x72h cm for 2 workplaces</i>	1 x 3109L E*	192
			375 cm		1 x 3109D E*	
			72 cm		1 x 3065 E 2 x 3067 2 x 3505 E	
3963 E		SB CH TR E SW TR E	160 cm	Kompozicija 3963 E dimenzije 160x163x72h cm za 2 radna mjesta <i>Composition 3963 E dimensions 160x163x72h cm for 2 workplaces</i>	2 x 3104 E*	124
			163 cm		1 x 3063 E 2 x 3067	
			72 cm		2 x 3501 E	
3964 E		SB CH TR E SW TR E	240 cm	Kompozicija 3964 E dimenzije 240x160x72h cm za 3 radna mjesta <i>Composition 3964 E dimensions 240x160x72h cm for 3 workplaces</i>	3 x 3104 E*	174
			160 cm		3 x 3501 E	
			72 cm			
3965 E		SB CH TR E SW TR E	323 cm	Kompozicija 3965 E dimenzije 323x163x72h cm za 4 radna mjesta <i>Composition 3965 E dimensions 323x163x72h cm for 4 workplaces</i>	4 x 3104 E*	254
			163 cm		2 x 3055 E 2 x 3051 E	
			72 cm		8 x 3067 4 x 3501 E	

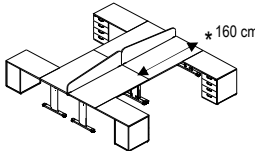
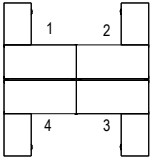

TREND ECONOMY metalne noge / TREND ECONOMY metal legs

ZAJEDNIČKA OZNAKA	SLIKA	IZBOR BOJA	DIM.(cm) š d v	OPIS	SASTAV	PAK. kg m3 paketa
ARTICLE CODE	PICTURE	COLOUR SELECTION	DIM.(cm) w d h	DESCRIPTION	ASSEMBLY	PACK. kg m3 col
3967 E	 	SB CH TR E SW TR E	320 cm	Kompozicija 3967 E dimenzije 320x363x72h cm za 4 radna mjesta	4 x 3104 E*	307
			363 cm		4 x 3507 E 2 x 3055 E 4 x 3067	
			72 cm	Composition 3967 E dimensions 320x363x72h cm for 4 workplaces		30

NAPOMENA: SVAKA OD NAVEDENIH KOMPOZICIJA MOŽE SE NUDITI U RAZLIČITIM VELIČINAMA RADNIH STOLOVA SA RAVNIM I KOSIM PREGRADAMA. TAKOĐER MOGUĆE JE PROŠIRITI ILI SMANJITI PREDLOŽENE KOMPOZICIJE S TIME DA OBRATITE POZORNOST NA RASPOLOŽIVI PROSTOR

REMARK: EACH COMPOSITION IS AVAILABLE IN DIFFERENT DIMENSIONS OF WORKTABLES WITH FLAT OR SLOPE PARTITION PANELS. IT IS ALWAYS POSSIBLE TO EXPAND OR REDUCE SUGGESTED COMPOSITIONS BUT PLEASE TAKE ATTENTION TO AVAILABLE SPACE AT YOUR SITE.

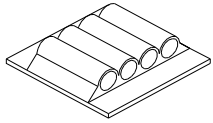
OSTALI DODACI STOLOVIMA
OTHER TABLE ACCESSORIES

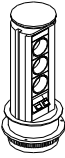
3094		CRNA SIVA BIJELA	6 cm	Držač za kablove 3094 dimenzije 6x6x0,5h cm, za sve radne i konferencijske stolove. Dostupna u crnoj, sivoj i bijeloj boji <i>Cable holder 3094 dimensions 6x6x0,5h cm, for all work and conference tables. Available in black, grey and white colour.</i>	1 x 3094	0,004
			6 cm			
			0.5 cm			1
3095		CRNA SIVA BIJELA	8 cm	Držač za kablove 3095 dimenzije 8x4x2h cm, za sve radne i konferencijske stolove. Dostupna u crnoj, sivoj i bijeloj boji <i>Cable holder 3095 dimensions 8x4x2h cm, for all work and conference tables. Available in black colour.</i>	1 x 3095	0,005
			4 cm			
			2 cm			1
3096		RAL 9006	6 cm	Držač za kablove 3096 dimenzije 6x6x66-77h cm, za sve radne i konferencijske stolove s metalnim nogama. <i>Cable holder 3096 dimensions 6x6x66-77h cm, for all work and conference tables with metal legs.</i>	1 x 3096	1
			6 cm			0,0288
			66-77 cm			1
3097		RAL 9006	10 cm	Izvlačne utičnice 3097 dimenzije 10x10x38h cm, za sve radne i konferencijske stolove s metalnim nogama. <i>Electrical socket extension 3097 dimensions 10x10x38h cm, for all work and conference tables with metal legs.</i>	1 x 3097	1
			10 cm			0,0121
			38 cm			1

TEHNIČKI OPIS

TECHNICAL DESCRIPTION

STOLOVI

TABLES

Završne ploče tj. topovi stolova izrađeni su od melaminskih panela debljine 25 mm. Rubovi stola kantirani su ABS rubnom trakom debljine 2mm zaobljenih rubova sa radijusom $r=2$ mm. Svi stolovi imaju funkciju vođenja kablova. Metalne noge raspoložive su u sivoj boji. Pregrade između stolova izrađuju se od melaminskih panela debljine 18mm kantiranih ABS rubnom trakom.

Tables are made of chipboard melamine panels 25mm thick. Table edges are covered with 2mm thick ABS tape with rounded edges ($r=2$ mm). All tables are equipped with modern design metal legs that have functionality of cable conducting. Metal legs are available in grey colour. Partition panels between tables are made from melamine panels 18mm thick. They are edgebanded with ABS.

DODACI STOLOVIMA

TABLE ENDS

Izrađeni su iz melaminskih panela debljine 25 mm u boji namještaja. Uz topove dodatka isporučujemo sive metalne noge.

Table ends are made of melamine panels 25mm thick. They are in colour of table. For work table ends we are delivering grey metal legs.

LADIČARI

CHEST OF DRAWERS

Stranice, top i fronte ladica izrađeni su iz melaminskih panela debljine 18 mm, te kantirani ABS rubnom trakom. Ladice su od melaminskih panela debljine 12 mm (stranice ladica) i lakiranog MDF-a debljine 4 mm (dno ladice). Kazete su opremljene bravicom koja omogućava simultano zaključavanje svih ladica ("centralno zaključavanje"). Pokretne kazete opremljene su kotačima. Okvir kazeta je u sivoj boji (SG 263), dok su završna ploča (top) i prednje ploča ladica (fronta) u boji namještaja. Sve kazete dodatno su opremljene plastičnim ladicama za pisali pripor. Posebno nudimo kazetu s metalnim metabox ladicama (3502).

Sides, top and drawer fronts are made of melamine panels 18mm thick with edges covered with ABS tape. Drawers are made of melamine panels 12mm thick (sides of drawer) and lacquered MDF 4mm thick (bottom of drawer). Chest of drawers is equipped with lock that enables simultaneous locking of all drawers ("central locking"). Movable chests of drawers are equipped with wheels. Frames are made of panels in grey colour (SG 263), while fronts and tops are made in colour of the furniture. All chest of drawers are additionally equipped with pen tray. Especially we offer chest of drawers with metal metabox drawers (3502).

NAPOMENA U VEZI IZBORA BOJA

REMARK ABOUT COLOURS

Navedene boje u našoj ponudi su uvijek identične u svakoj isporuci. Međutim naziv (trešnja, javor i sl.) niti približno ne definira boju iverala. Na tržištu se mogu pojaviti stotine različitih varijacija pod oznakom npr. trešnja, a što je posljedica uzgoja ovog drveta u vrlo različitim klimatskim uvjetima. Isto tako i boje siva, antracit i sl. mogu se pojaviti u puno različitih nijansi. Zbog navedenog razloga na našim dostavnim dokumentima navodimo klauzulu: "Reklamaciju na vaš odabir boja nakon isporuke ne prihvaćamo".

Available colours in our assortment are identical in every delivery. However, the name (cherry, maple etc.) does not indicate the exact design. There are hundreds of different variations under the name for example cherry, which is caused by growing of cherry tree in different climate conditions. Uni colours like gray, anthracite etc. can also be in different designs. Due to above stated there is a remark on our delivery documentation: "After delivery, complaint on your selection of colours will not be accepted"

TREND ECONOMY ormari

TREND ECONOMY bookcases



BOJE - COLOURS

SB

bukva
beech
SBE 83B

SW TRE

orah
walnut
SW 4L8

CH TRE



trešnja
cherry
SCH 8H7





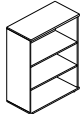
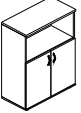
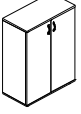
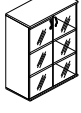
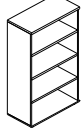
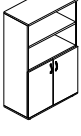

TREND ECONOMY ormar / TREND ECONOMY bookcases

ZAJEDNIČKA OZNAKA	SLIKA	IZBOR BOJA	DIM.(cm) š d v	OPIS	SASTAV	PAK. kg m3 paketa
ARTICLE CODE	PICTURE	COLOUR SELECTION	DIM.(cm) w d h	DESCRIPTION	ASSEMBLY	PACK. kg m3 col

FOKUS ORMARI ŠIRINE 80 cm I DUBINE 40 cm BOJA OKVIRA ORMARA U BOJI NAMJEŠTAJA
FOKUS BOOKCASES WIDTH 80 cm AND DEPTH 40 cm STRUCTURE COLOUR IN COLOUR OF FURNITURE

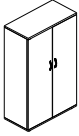
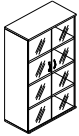
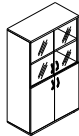
3701 E		SB CH TR E SW TR E	80 cm	Fokus niski ormar 3701 E dimenzije 80x40x79h cm otvoreni s 1 policom	1 x 3701 E	23
			40 cm	Fokus low bookcase 3701 E dimensions 80x40x79h cm open with 1 shelf		0,0544
			79 cm			3
3702 E		SB CH TR E SW TR E	80 cm	Fokus niski ormar 3702 E dimenzije 80x40x79h cm s drvenim vratima i 1 policom bez bravice	1 x 3702 E	31
			40 cm	Fokus low bookcase 3702 E dimensions 80x40x79h cm with wooden doors and 1 shelf without lock		0,0716
			79 cm			4
3703 E		SB CH TR E SW TR E	80 cm	Fokus niski ormar 3703 E dimenzije 80x40x79h cm s staklenim vratima i 1 policom bez bravice	1 x 3703 E	31
			40 cm	Fokus low bookcase 3703 E dimensions 80x40x79h cm with glass doors and 1 shelf without lock		0,0704
			79 cm			4
3711 E		SB CH TR E SW TR E	80 cm	Fokus srednji niži ormar 3711 E dimenzije 80x40x120h cm otvoreni s 2 police	1 x 3711 E	35
			40 cm	Fokus medium low bookcase 3711 E dimensions 80x40x120h cm open with 2 shelves		0,0744
			120 cm			3
3714 E		SB CH TR E SW TR E	80 cm	Fokus srednji niži ormar 3714 E dimenzije 80x40x120h cm s niskim drvenim vratima i 2 police bez bravice	1 x 3714 E	43
			40 cm	Fokus medium low bookcase 3714 E dimensions 80x40x120h cm with low wooden doors and 2 shelves without lock		0,0916
			120 cm			4
3712 E		SB CH TR E SW TR E	80 cm	Fokus srednji niži ormar 3712 E dimenzije 80x40x120h cm s drvenim vratima i 2 police bez bravice	1 x 3712 E	47
			40 cm	Fokus medium low bookcase 3712 E dimensions 80x40x120h cm with wooden doors and 2 shelves without lock		0,1073
			120 cm			4
3713 E		SB CH TR E SW TR E	80 cm	Fokus srednji niži ormar 3713 E dimenzije 80x40x120h cm s staklenim vratima i 2 police bez bravice	1 x 3713 E	45
			40 cm	Fokus medium low bookcase 3713 E dimensions 80x40x120h cm with glass doors and 2 shelves without lock		0,0952
			120 cm			4
3721 E		SB CH TR E SW TR E	80 cm	Fokus srednji viši ormar 3721 E dimenzije 80x40x149h cm otvoreni s 3 police	1 x 3721 E	41
			40 cm	Fokus medium high bookcase 3721 E dimensions 80x40x149h cm open with 3 shelves		0,0744
			149 cm			3
3724 E		SB CH TR E SW TR E	80 cm	Fokus srednji viši ormar 3724 E dimenzije 80x40x149h cm s niskim drvenim vratima i 3 police bez bravice	1 x 3724 E	49
			40 cm	Fokus medium high bookcase 3724 E dimensions 80x40x149h cm with low wooden doors and 3 shelves without lock		0,0916
			149 cm			4

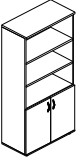
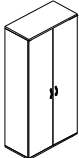

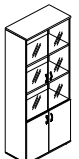

TREND ECONOMY ormar / TREND ECONOMY bookcases

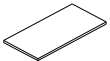
ZAJEDNIČKA OZNAKA	SLIKA	IZBOR BOJA	DIM.(cm) š d v	OPIS	SASTAV	PAK. kg m3 paketa
ARTICLE CODE	PICTURE	COLOUR SELECTION	DIM.(cm) w d h	DESCRIPTION	ASSEMBLY	PACK. kg m3 col
3722 E		SB CH TR E SW TR E	80 cm	Fokus srednji viši ormar 3722 E dimenzije 80x40x149h cm s drvenim vratima i 3 police bez bravice	1 x 3722 E	56
			40 cm	<i>Fokus medium high bookcase 3722 E</i>		0,1073
			149 cm	<i>dimensions 80x40x149h cm with wooden doors and 3 shelves without lock</i>		4
3723 E		SB CH TR E SW TR E	80 cm	Fokus srednji viši ormar 3723 E dimenzije 80x40x149h cm s staklenim vratima i 3 police bez bravice	1 x 3723 E	55
			40 cm	<i>Fokus medium high bookcase 3723 E</i>		0,0999
			149 cm	<i>dimensions 80x40x149h cm with glass doors and 3 shelves without lock</i>		4
3725 E		SB CH TR E SW TR E	80 cm	Fokus srednji viši ormar 3725 E dimenzije 80x40x149h cm s drvenim i staklenim vratima i 3 police bez bravice	1 x 3725 E	57
			40 cm	<i>Fokus medium high bookcase 3725 E</i>		0,1076
			149 cm	<i>dimensions 80x40x149h cm with wooden and glass doors and 3 shelves without lock</i>		5
3731 E		SB CH TR E SW TR E	80 cm	Fokus visoki ormar 3731 E dimenzije 80x40x190h cm otvoreni s 4 police	1 x 3731 E	49
			40 cm			0,1044
			190 cm	<i>Fokus high bookcase 3731 E dimensions 80x40x190h cm open with 4 shelves</i>		3
3733 E		SB CH TR E SW TR E	80 cm	Fokus visoki ormar 3733 E dimenzije 80x40x190h cm s niskim drvenim vratima i 4 police bez bravice	1 x 3733 E	57
			40 cm	<i>Fokus high bookcase 3733 E dimensions</i>		0,1216
			190 cm	<i>80x40x190h cm with low wooden doors and 4 shelves without lock</i>		4
3732 E		SB CH TR E SW TR E	80 cm	Fokus visoki ormar 3732 E dimenzije 80x40x190h cm s drvenim vratima i 4 police bez bravice	1 x 3732 E	69
			40 cm	<i>Fokus high bookcase 3732 E dimensions</i>		0,1459
			190 cm	<i>80x40x190h cm with wooden doors and 4 shelves without lock</i>		4
3734 E		SB CH TR E SW TR E	80 cm	Fokus visoki ormar 3734 E dimenzije 80x40x190h cm s drvenim i staklenim vratima i 4 police bez bravice	1 x 3734 E	67
			40 cm	<i>Fokus high bookcase 3734 E dimensions</i>		0,1424
			190 cm	<i>80x40x190h cm with wooden and glass doors and 4 shelves without lock</i>		5
3741 E		SB CH TR E SW TR E	80 cm	Fokus visoki ormar 3741 E dimenzije 80x40x219h cm s drvenim i staklenim vratima i 4 police bez bravice	1 x 3741 E	79
			40 cm	<i>Fokus high bookcase 3741 E dimensions</i>		0,1621
			219 cm	<i>80x40x219h cm with wooden and glass doors and 4 shelves without lock</i>		5

OSTALI DODACI ZA ORMARE I URED
ACCESSORIES FOR BOOKCASES AND OFFICE

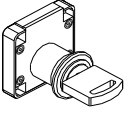
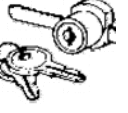
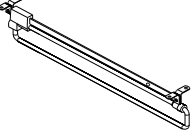
SH80 E		SB CH TR E SW TR E	80 cm	Fokus dodatna polica za ormar dimenzije 80x40x1,8h cm	1 x SH80 E	4
			40 cm			0,0057
			1,8 cm	<i>Fokus extra shelf for bookcase lenght 80 dimensions 80x40x1,8h cm</i>		1

TREND ECONOMY ormani / TREND ECONOMY bookcases

ZAJEDNIČKA OZNAKA	SLIKA	IZBOR BOJA	DIM.(cm) š d v	OPIS	SASTAV	PAK. kg m3 paketa
ARTICLE CODE	PICTURE	COLOUR SELECTION	DIM.(cm) w d h	DESCRIPTION	ASSEMBLY	PACK. kg m3 col
A/LCK		CHROM	2 cm	Bravica za sva drvena vrata ormara dimenzije 2x2x4h cm	1 x A/LCK	0,2
			2 cm	Lock for all wooden doors dimensions 2x2x4h cm		0,0001
			4 cm		1	
A/LCKS		CHROM	2 cm	Bravica za sva staklena vrata ormara dimenzije 2x2x4h cm	1 x A/LCKS	0,2
			2 cm	Lock for all glass doors dimensions 2x2x4h cm		0,0001
			4 cm		1	
A/HGR		CHROM	36 cm	Izvlačna vješalica za garderobni ormar dimenzije 36x4x6h cm	1 x A/HGR	0,4
			4 cm	Extension hanger for wardrobe dimensions 36x4x6h cm		0,001
			6 cm		1	
SVB		CRNA	56 cm	Samostojeća vješalica GIR CRNA dimenzije 56x56x175h cm	1 x SVB	5
			56 cm	Wardrobe hanger GIR BLACK dimensions 56x56x175h cm		0,0296
			175 cm		1	
SVC		CHROM	56 cm	Samostojeća vješalica GIR CHROM dimenzije 56x56x175h cm	1 x SVC	5
			56 cm	Wardrobe hanger GIR CHROM dimensions 56x56x175h cm		0,0296
			175 cm		1	
KZS		CRNA	28 cm	Koš za smeće žičani dimenzije Ø28x35h cm	1 x KZS	0,5
			28 cm		0,0361	
			35 cm	Trash basket dimensions Ø28x35h cm	1	

**PRIMJERI SLOŽENIH KOMPOZICIJA FOKUS ORMARA
BOJA OKVIRA U BOJI NAMJEŠTAJA**

EXAMPLES OF ASSEMBLED COMPOSITIONS FOKUS BOOKCASES
STRUCTURE COLOUR IN COLOUR OF FURNITURE

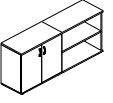
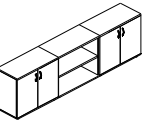
3915 E		SB CH TR E SW TR E	160 cm	Fokus kompozicija ormara 3915 E dimenzije 160x40x79h cm	1 x 3702 E 1 x 3701 E	54
			40 cm	Fokus composition of bookcases 3915 E dimensions 160x40x79h cm		0,126
			79 cm		7	
3916 E		SB CH TR E SW TR E	240 cm	Fokus kompozicija ormara 3916 E dimenzije 240x40x79h cm	2 x 3702 E 1 x 3701 E	85
			40 cm	Fokus composition of bookcases 3916 E dimensions 240x40x79h cm		0,1976
			79 cm		11	

TREND ECONOMY ormani / TREND ECONOMY bookcases

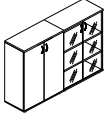
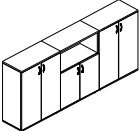
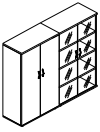
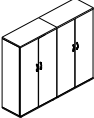
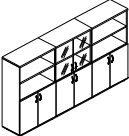
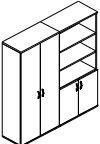
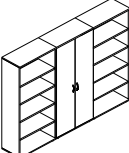
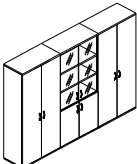
ZAJEDNIČKA OZNAKA	SLIKA	IZBOR BOJA	DIM.(cm) š d v	OPIS	SASTAV	PAK. kg m3 paketa
ARTICLE CODE	PICTURE	COLOUR SELECTION	DIM.(cm) w d h	DESCRIPTION	ASSEMBLY	PACK. kg m3 col
3917 E		SB CH TR E SW TR E	160 cm	Fokus kompozicija ormara 3917 E dimenzije 180x40x120h cm	1 x 3712 E 1 x 3713 E	92
			40 cm	Fokus composition of bookcases 3917 E dimensions 180x40x120h cm		0,2025
			120 cm			8
3918 E		SB CH TR E SW TR E	240 cm	Fokus kompozicija ormara 3918 E dimenzije 240x40x120h cm	2 x 3712 E 1 x 3714 E	137
			40 cm	Fokus composition of bookcases 3918 E dimensions 240x40x120h cm		0,3062
			120 cm			12
3919 E		SB CH TR E SW TR E	160 cm	Fokus kompozicija ormara 3919 E dimenzije 160x40x149h cm	1 x 3722 E 1 x 3723 E	111
			40 cm	Fokus composition of bookcases 3919 E dimensions 160x40x149h cm		0,2072
			149 cm			8
3920 E		SB CH TR E SW TR E	180 cm	Fokus kompozicija ormara 3920 E dimenzije 180x40x149h cm	2 x 3722 E	112
			40 cm	Fokus composition of bookcases 3920 E dimensions 180x40x149h cm		0,2146
			149 cm			8
3921 E		SB CH TR E SW TR E	240 cm	Fokus kompozicija ormara 3921 E dimenzije 240x40x149h cm	1 x 3725 E 2 x 3724 E	155
			40 cm	Fokus composition of bookcases 3921 E dimensions 240x40x149h cm		0,2908
			149 cm			13
3922 E		SB CH TR E SW TR E	160 cm	Fokus kompozicija ormara 3922 E dimenzije 160x40x190h cm	1 x 3732 E 1 x 3733 E	126
			40 cm	Fokus composition of bookcases 3922 E dimensions 160x40x190h cm		0,2675
			190 cm			8
3923 E		SB CH TR E SW TR E	240 cm	Fokus kompozicija ormara 3923 E dimenzije 240x40x190h cm	2 x 3731 E 1 x 3732 E	167
			40 cm	Fokus composition of bookcases 3923 E dimensions 240x40x190h cm		0,3547
			190 cm			10
3924 E		SB CH TR E SW TR E	240 cm	Fokus kompozicija ormara 3924 E dimenzije 240x40x190h cm	2 x 3732 E 1 x 3734 E	205
			40 cm	Fokus composition of bookcases 3924 E dimensions 240x40x190h cm		0,4342
			190 cm			13

Napomena: Kod kompozicija ormara na Vaš zahtjev možemo po istoj cijeni isporučiti jedan top za ukupnu dužinu.

Međutim, ako u budućnosti rasformirate kompoziciju trebati će dorada (prekranjanje topa).

Remark: When combining more than one bookcase, we are able to deliver one bookcase top for the whole length. However, if in the future You will separate composition, additional cutting of the top would have to be done.

NAPOMENA: UKOLIKO NARUČUJETE BILO KOJA STAKLENA VRATA SA BRAVICOM POTREBNO JE TO ODMAH NAVESTI U NARUDŽBI.

REMARK: IF YOU ORDER ANY GLASS DOORS WITH LOCK, YOU MUST INDICATE THAT IN YOUR ORDER.

TEHNIČKI OPIS

TECHNICAL DESCRIPTION

ORMARI
BOOKCASES

Izrađeni su od melaminskih panela u debljinama kako slijedi: bočne stranice, vrata i police 18 mm; završna ploča 25 mm. Svi rubovi ormara (uključujući i police) su kantirani ABS rubnom trakom. Leđa su izrađena od MDF-a 4mm obostrano lakirana. Ormari su opremljeni nožicama za regulaciju visine podesivim iznutra. Staklena vrata su debljine 5 mm. Kao opcije se mogu dobiti i dodatne police za ormar, kao i bravice za zaključavanje. Okviri ormara, topovi i vrata su u boji namještaja, dok su leđa sive boje.

Bookcases are made of melamine panels in thickness as follows: side panels, fronts and shelves 18mm; tops 25 mm. All edges of bookcase (including shelves) are covered with ABS tape. Back side is made of MDF 4mm lacquered on both sides. Bookcases are equipped with legs for height regulation that are adjustable from the inside. Glass doors have thickness of 5mm. Additional shelves and locks can be delivered as option too. Bookcase frames, tops and fronts are in colour of the furniture, while back side is in grey colour.

NAPOMENA U VEZI IZBORA BOJA
REMARK ABOUT COLOURS

Navedene boje u našoj ponudi su uvijek identične u svakoj isporuci. Međutim naziv (trešnja, javor i sl.) niti približno ne definira boju iverala. Na tržištu se mogu pojaviti stotine različitih varijacija pod oznakom npr. trešnja, a što je posljedica uzgoja ovog drveta u vrlo različitim klimatskim uvjetima. Isto tako i boje siva, antracit i sl. mogu se pojaviti u puno različitih nijansi. Zbog navedenog razloga na našim dostavnim dokumentima navodimo klauzulu: "Reklamaciju na vaš odabir boja nakon isporuke ne prihvaćamo".

Available colours in our assortment are identical in every delivery. However, the name (cherry, maple etc.) does not indicate the exact design. There are hundreds of different variations under the name for example cherry, which is caused by growing of cherry tree in different climate conditions. Uni colours like gray, anthracite etc. can also be in different designs. Due to above stated there is a remark on our delivery documentation: "After delivery, complaint on your selection of colours will not be accepted"